

Expanding your opportunities

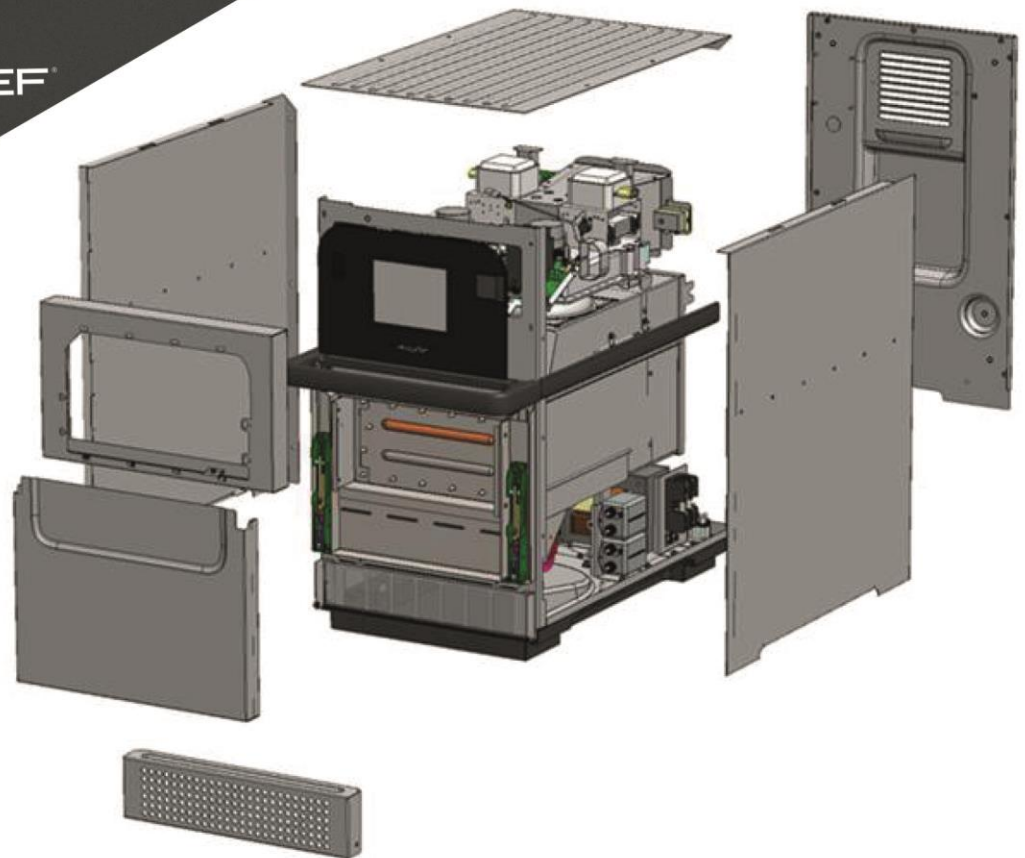

eikon[®] e2s

GB

Microwave Combination Oven
Service and Repair Manual CE – Original, GB



Contents

1	General information	4
1.1	EC Declaration of Conformity	5
1.2	Environmental protection	7
1.3	Important Information	8
1.4	Identifying your microwave combination oven	9
1.5	Structure of technical documentation	10
1.6	About this Service and Repair Manual	11
2	Design and function	13
2.1	Design and function of the microwave combination oven	14
2.2	Layout and function of the operating panel	16
3	For your safety	17
3.1	Basic safety code	18
3.2	Intended use of your microwave combination oven	23
3.3	Warning signs on your microwave combination oven	24
3.4	Summary of hazards	26
3.5	Hazards and safety precautions when moving the appliance	28
3.6	Hazards and safety precautions when setting up the appliance	29
3.7	Hazards and safety precautions during installing	30
3.8	Hazards and safety precautions when preparing appliance for use	31
3.9	Hazards and safety precautions during cleaning	32
3.10	Hazards and safety precautions during servicing and repair	34
3.11	Hazards and safety precautions when taking the appliance out of service	36
3.12	Safety devices	37
3.13	Requirements to be met by personnel and working positions	39
3.14	Personal protective equipment	40
4	Setting up the appliance	42
4.1	Safe working when setting up the appliance	43
4.2	Requirements for the installation location	44
4.3	Mounting the appliance on a work surface	46
5	Installation	47
5.1	Safe working during electrical installation	48
5.2	Planning the electrical installation	49
5.3	Electrical installation requirements	51
6	Preparing the appliance for use	53
6.1	Safe working when preparing the appliance for use	54
6.2	Procedure for preparing the appliance for use	56
6.3	Main menu screen	58
6.4	The keyboard screen	59
6.5	Using a USB stick	60
7	Cleaning procedures	62
7.1	Daily cleaning tasks	63
7.2	Cleaning chemicals	64

7.3	Items required for cleaning	65
7.4	Safe working when cleaning	66
7.5	Cleaning procedures	68
7.5.1	Cool down procedure before cleaning	69
7.5.2	Cleaning instructions	72
8	Technical data	77
8.1	Technical data	78
8.2	Dimensional drawings	80
9	Diagnostics	81
9.1	Checking the condition of your appliance	82
9.2	Errors and diagnostics	86
9.3	Fault finding	93
10	Tests	98
10.1	Safe working when testing components	99
10.2	Requirements	101
10.3	Testing selected components (casing mounted)	102
10.4	High voltage components (casing removed)	110
10.5	Mains voltage components (casing removed)	114
11	Firmware	115
11.1	Firmware Updates	116
12	Replacing components	131
12.1	Safe working when replacing appliance parts	132
12.2	Overview	134
12.3	Removing / fitting the casing	139
12.4	Removing / fitting the door assembly	142
12.5	Replacing a magnetron	147
12.6	Replacing the cooling fan	152
12.7	Replacing the QTS (Quick Touch Screen) assembly	154
12.8	Replacing the SRB (Smart Relay Board)	158
12.9	Replacing the touchscreen overlay	160
12.10	Adjusting the door microswitches / interlocks	162
12.11	Replacing the stirrer motor	164
12.12	Replacing the convection fan motor	168
12.13	Replacing a transformer (high voltage)	171
12.14	Removing the convection fan motor speed controller	174
12.15	Overview - further components	176
13	Circuit boards and diagrams	183
13.1	SRB / QTS circuit boards	184
13.2	Circuit diagrams	189
14	Commissioning the appliance	191

1 General information

Purpose of this chapter

This chapter shows you how to identify your microwave combination oven and provides guidance on using this manual.

Contents

This chapter contains the following topics:

	Page
EC Declaration of Conformity	5
Environmental protection	7
Important Information	8
Identifying your microwave combination oven	9
Structure of technical documentation	10
About this Service and Repair Manual	11

1.1 EC Declaration of Conformity

Manufacturer

Authorised Representative (Brand Headquarters)

Welbilt UK Limited
Ashbourne House, The Guildway,
Old Portsmouth Road
Guildford GU3 1LR
United Kingdom

Factory

Welbilt UK Limited
Provincial Park, Nether Lane,
Ecclesfield
Sheffield S35 9ZX
United Kingdom

Equipment details

Generic Model Number eikon e2s
Description Commercial Combination Microwave Oven

Declaration of Conformity with directives and standards

The manufacturer hereby declares that this commercial combination microwave oven complies with the following directives and standards.

Compliance with Directives

This commercial combination microwave oven complies with the relevant provisions of the following European Directives:

EMC 2004/108/EC RoHS 2011/65/EU MD 2006/42/EC

Harmonised standards applied

This commercial combination microwave oven complies with the relevant requirements of the following European standards:

EN 60335-2-90:2006 +A1 (excluding Annex EE ship board requirements)

EN 60335-1:2012

EN 62233:2008

EN 55014-2:1997+A2:2008 in accordance with Category IV requirements

- Electrostatic discharge IEC 61000-4-2
- Radiated RF interference IEC 61000-4-3
- Fast transient common mode, AC port IEC 61000-4-4
- Mains surge, AC port IEC 61000-4-5
- RF current, common mode, AC port IEC 61000-4-6
- Mains voltage dips and interruptions IEC 61000-4-11
- Flicker IEC 61000-3-11

EN 55011:2009+A1:2010 Classification: Class A, Group 2

- Mains terminal disturbance voltage Table 6
- Radiated disturbance, magnetic field Table 9
- Radiated disturbance, electric field Table 9

AS/NZS CISPR 11

- Radiated disturbance CISPR 11:2009 Class A
- Conducted disturbance CISPR 11:2009 Class A

Manufacturer

Place and Date of issue: Guildford, 31st July 2015



Mr Philip Radford

Vice President Products: Merrychef
(on behalf of the Authorised Representative)

Quality and environmental management

Welbilt UK Limited (Sheffield) employs a quality management system in accordance with EN ISO 9001:2008 and a certified environmental management system in accordance with EN ISO 14001.

1.2 Environmental protection

Statement of principles

Our customers' expectations, the legal regulations and standards and our company's own reputation set the quality and service for all our products.

We have an environmental management policy that not only ensures compliance with all environmental regulations and laws, but also commits us to continuous improvement of our green credentials.

We have developed a quality and environmental management system in order to guarantee the continued manufacture of high-quality products and to be sure of meeting our environmental targets.

This system satisfies the requirements of ISO 9001:2008 and ISO 14001:2004.

Environmental protection procedures

We observe the following procedures:

- Use of RoHS2-compliant products
- REACH chemical law
- Recycling of electronic waste
- Environmentally friendly disposal of old appliances via the manufacturer

Join us in our commitment to protect the environment.

1.3 Important Information

Users are cautioned that maintenance and repairs should be performed by a Merrychef® authorised service agent using genuine Merrychef® replacement parts. Merrychef® will have no obligation with respect to any product that has been improperly installed, adjusted, operated or not maintained in accordance with national and local codes or installation instructions provided with the product, or any product that has its serial number defaced, obliterated or removed, or which has been modified or repaired using unauthorised parts or by unauthorised service agents. For a list of authorised service agents please refer to your distributor.

1.4 Identifying your microwave combination oven

Position of nameplate

The nameplate is located on the rear of your microwave combination oven.

1 Model number
eikon e2s

2 Elements of the item number

	Label	Meaning
Model	e2s	
Power output convection	D	2200W
	F	2200W / 1300W
	G	2200W / 900W
Power output microwave	B	2000W (High Power version)
	X	1000W (Standard Power version)
	30	230V
Voltage	MV5	220-230V / 50Hz
	MV6	208-240V / 60Hz
	00	200V
Frequency	20	220V
	5	50Hz
Lead	6	60Hz
	A - Z	Example: H = L+N+E (4mm EU)
Plug	A - Z	Example: E = 3-pin plug
Communication	L	USB + LAN
	U	USB
Version	A, B	A, B (pre-production)
	1, 2, ...	1, 2, ... (serial production)
Accessory / Customer	CF	"Trend" exterior
	CL	"Classic" exterior
	WW	Specific customer
Region / Country	EU	Europe
	US	United States of America

3 Elements of the serial number

	Label	Meaning
Year of manufacture	15	2015
	16, ...	2016, ...
Month of manufacture	01	January
	02, ...	February, ...
Place of manufacture	2130	Sheffield (UK)
Production number	12345	

4 Technical data

5 Date of manufacture

1.5 Structure of technical documentation

Contents

The technical documentation for the microwave combination oven includes the following documents:

- Installation and Operating Manual
- Service and Repair Manual (this document)

1.6 About this Service and Repair Manual

Purpose

This Service and Repair Manual is intended for all trained service technicians who work with the microwave combination oven, and provides them with the necessary information for carrying out servicing and repair work properly and safely.

Who should read the Service and Repair Manual

Name of target group	Tasks
Trained service technicians	All servicing and repair work

Parts of this document that must be read without fail

If you do not follow the information in this document, you risk potentially fatal injury and property damage.

To guarantee safety, all people who work with the microwave combination oven must have read and understood the following parts of this document before starting any work:

- The chapter '*For your safety*' on page 17
- The sections that describe the activity to be carried out

Chapters in the service and repair manual

Chapter/section	Purpose
General information	<ul style="list-style-type: none"> ▪ Shows you how to identify your appliance ▪ Provides guidance on using this Service and Repair Manual
Design and function	<ul style="list-style-type: none"> ▪ Specifies the intended use of the appliance ▪ Explains the functions of the appliance and shows the position of its components
For your safety	<ul style="list-style-type: none"> ▪ Describes the hazards posed by the appliance and suitable preventive measures ▪ It is important that you read this chapter carefully.
Setting up the appliance	<ul style="list-style-type: none"> ▪ Explains how to unpack the appliance and specifies the parts supplied with the appliance ▪ Explains how to set up the appliance
Installation	Provides information on installing the electrical supply
Preparing the appliance for use	Explains the procedure for preparing the appliance for first-time use
Cleaning procedures	<ul style="list-style-type: none"> ▪ Explains the principles of the cleaning methods ▪ Contains the cleaning instructions ▪ Describes the cleaning chemicals and how to prepare them for use ▪ Contains the instructions for working procedures during cleaning ▪ Contains and refers to the instructions for handling operations on the microwave combination oven regularly performed during cleaning
Technical data	Contains the technical data and dimensional drawings
Diagnostics	Contains a catalogue of potential errors and faults and specifies the required actions
Tests	Contains instructions about testing various components of the appliance
Firmware	Explains the procedure to check and to update the firmware of the appliance
Replacing components	Contains instructions for removing and fitting the appliance parts in order to repair a defective appliance



Chapter/section	Purpose
Circuit diagrams and boards	Shows electrical circuit diagrams and terminal locations on boards
Commissioning the appliance	Contains checklists which actions to take when preparing the appliance for first time-use and recommissioning it after service/repair.

Safety alert symbol

Safety alert symbol	Meaning
	Warns of potential injuries. Heed all the warning notices that appear after this symbol to avoid potential injuries or death.

Form of warning notices

The warning notices are categorized according to the following hazard levels:

Hazard level	Consequences	Likelihood
 DANGER	Death / serious injury (irreversible)	Immediate risk
 WARNING	Death / serious injury (irreversible)	Potential risk
 CAUTION	Minor injury (reversible)	Potential risk
NOTICE	Damage to property	Potential risk

Decimal points

Decimal points are used throughout this manual in any language available.

2 Design and function

Purpose of this chapter

This chapter describes the design and construction of the microwave combination oven and explains its functions.

Contents

This chapter contains the following topics:

	Page
Design and function of the microwave combination oven	14
Layout and function of the operating panel	16

2.1 Design and function of the microwave combination oven

Parts and their function

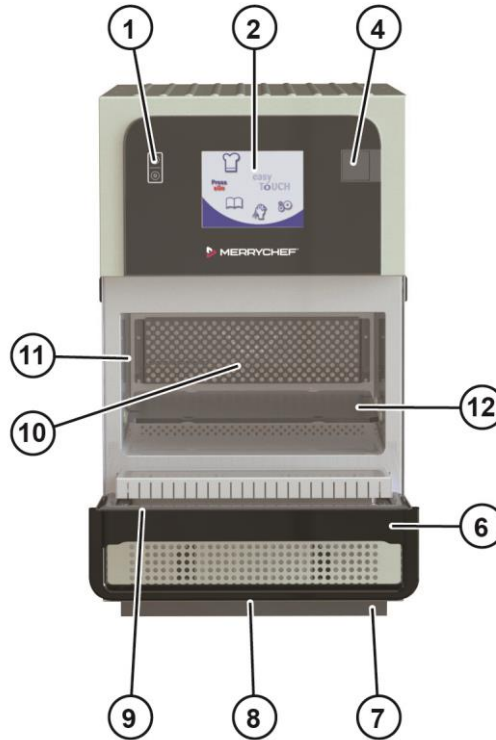

Item	Name	Function
1	ON/OFF appliance switch	Used to turn the microwave combination oven on and off. Turning this switch off does not isolate the appliance from the electricity supply.
2	easyToUCH® screen control panel	When the appliance is switched on the easyToUCH® screen illuminates the user interface. See 'Cooking procedures' for details.
3	Nameplate (no picture)	Located on the rear panel of the appliance the nameplate states the serial number, model type and electrical specifications.
4	USB port	A USB socket located under the cover allows updates to programs stored on the appliance. See USB MenuConnect® User Manual. See 'Cooking procedures' section of this manual, for details of updating cooking profiles.
5	Air outlets (no picture)	Air used to cool internal components and steam from the cavity escape through the air outlet vents located on the rear of the appliance. The air outlets must be kept free from obstruction and they will not allow microwave energy to escape into the environment.
6	Appliance door	The door is a precision-made energy barrier with three microwave safety interlocks. Always keep it clean and do not use it to support heavy objects. See 'Cleaning procedures' on page 62.
7	Air filter	The air filter situated at the lower front of the appliance is part of the ventilation system. Keep it free of obstruction and clean it daily as described under 'Cleaning procedures' on page 62. The appliance will not operate without the air filter fitted.

Item	Name	Function
8	Door handle	The door handle is a rigid bar which is pulled downwards and away from the appliance to open it.
9	Door seals	The door seals ensure a tight seal around the door. Always keep them clean and check regularly for signs of damage. At the first sign of wear have them replaced by a Merrychef approved service agent. See ' <i>Cleaning procedures</i> ' on page 62.
10	Air diffuser (not fitted to all appliances)	Keep the air diffuser clean and free of debris. Take great care when cleaning this area of the appliance noting the different requirements shown under ' <i>Cleaning procedures</i> ' on page 62 in this manual.
11	Cavity	The cavity (cooking chamber) is constructed from stainless steel and used for cooking products. Keep it clean by following the cleaning instructions in the ' <i>Cleaning procedures</i> ' on page 62 section of this manual.
12	Cook plate	The cook plate is flat and square with all four sides having circular dips for easily fitting onto the cavity support stubs (Two on each side). Both sides of the cook plate can be used for cooking and all sides are designed to fit onto the cavity support stubs.

Material

The interior and exterior structure of the appliance is made of stainless steel in either a brushed finish or colour-coded.

2.2 Layout and function of the operating panel

Elements and their function

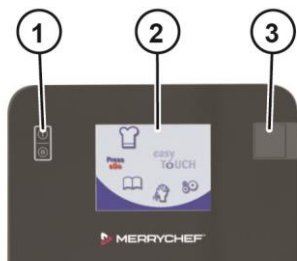

Item	Name	Function
1	ON/OFF appliance switch	Switches the microwave combination oven on and off.
2	Touchscreen	Central controls of the appliance <ul style="list-style-type: none">▪ Appliance operated by touching icons on touchscreen pages▪ Status displays
3	USB port	For connecting a USB memory stick

3 For your safety

Purpose of this chapter

This chapter provides you with all the information you need in order to use the microwave combination oven safely without putting yourself or others at risk.

This is a particularly important chapter that you must read through carefully.

Contents

This chapter contains the following topics:

	Page
Basic safety code	18
Intended use of your microwave combination oven	23
Warning signs on your microwave combination oven	24
Summary of hazards	26
Hazards and safety precautions when moving the appliance	28
Hazards and safety precautions when setting up the appliance	29
Hazards and safety precautions during installing	30
Hazards and safety precautions when preparing appliance for use	31
Hazards and safety precautions during cleaning	32
Hazards and safety precautions during servicing and repair	34
Hazards and safety precautions when taking the appliance out of service	36
Safety devices	37
Requirements to be met by personnel and working positions	39
Personal protective equipment	40



3.1 Basic safety code

Object of this safety code

This safety code aims to ensure that all persons who use the microwave combination oven have a thorough knowledge of the hazards and safety precautions, and that they follow the warning notices given in the user manual and on the appliance. If you do not follow this safety code, you risk potentially fatal injury and property damage.

Referring to the user manuals included in the customer documentation

Follow the instructions below:

- Read in full the chapter '*For Your Safety*' on page 17 and the chapters that relate to your work.
- Always keep to hand the manuals included in the customer documentation for reference.
- Pass on the user manuals included in the customer documentation with the microwave combination oven if it changes ownership.

Personal protective equipment for your personnel

Instruct your personnel to wear the correct personal protective equipment specified in the section '*Personal protective equipment*' on page 40 in the '*For your safety*' chapter for the relevant tasks.

Ground rules for installation

Installation must comply with all national and regional laws and regulations and comply with the local regulations of the relevant utility companies and local authorities and with other relevant requirements.

Working with the microwave combination oven

Follow the instructions below:

- Only those persons who satisfy the requirements stipulated in this installation and operating manual are permitted to use the microwave combination oven.
- Only use the microwave combination oven for the specified use. Never, under any circumstances, use the microwave combination oven for other purposes.
- Take all the safety precautions specified in this installation and operating manual and on the microwave combination oven. In particular, use the prescribed personal protective equipment.
- Only stand in the working positions specified.
- Do not make any changes to the microwave combination oven, e. g. removing parts or fitting un-approved parts. In particular, you must not disable any safety devices.

IMPORTANT SAFETY INSTRUCTIONS

When using electrical appliances basic safety precautions should be followed, including the following:

WARNING – To reduce the risk of burns, electric shock, fire, injury to persons, or exposure to excessive microwave energy:

- Read all instructions before using the appliance.
- Install or locate this appliance only in accordance with the provided installation instructions.

Restrictions on use

- Only use utensils that are suitable for use in microwave combination ovens. See 'Procedure for preparing the appliance for use'.
- Do not use corrosive chemicals or vapors in this appliance. This type of oven is specifically designed to heat, cook or toast food. It is not designed for industrial or laboratory use.
- Never use the appliance to heat alcohol, e. g. brandy, rum, etc. Food containing alcohol can more easily catch fire if overheated. Observe caution and do not leave the appliance unattended.

- Never attempt to deep fry in the oven.
- Eggs in their shell and whole hard boiled eggs should not be heated in microwave ovens since they may explode even after microwave heating has ended.
- Do not operate the appliance using microwave only or combination function without food or liquid inside the cooking chamber as this may result in overheating and may cause damage.
- The appliance should not be used to dry linen.
- **WARNING:** Liquids and other foods must not be heated in completely sealed containers as the build-up of steam may cause them to explode.
- Do not attempt to operate the appliance with: an object caught in the door, door that does not close properly; a damaged door, hinge, latch, sealing surface or without food in the oven.

Precautions when using the microwave combination oven

- **WARNING:** Microwave heating of beverages can result in delayed eruptive boiling. Therefore care must be taken when handling the container.
- When handling hot liquids, foods and containers, care should be taken to avoid scalds and burns.
- As with any cooking appliance, care should be taken to avoid combustion of the items within the appliance.

Instructions for safe use of the microwave combination oven

- When heating liquids using microwave only or combination function, the contents should be stirred prior to heating to help prevent eruptive boiling.
- **WARNING:** The contents of feeding bottles and baby food jars must be stirred or shaken and the temperature checked before consumption, in order to avoid burns.
- Items should be unwrapped when using convection and combination functions.
- Excess fat should be removed during 'roasting' and before lifting heavy containers from the oven.
- Food with a skin, e. g. potatoes, apples, sausages, etc. should be pierced before heating.
- When heating food in plastic or paper containers, keep an eye on the oven due to the possibility of ignition.
- Food in combustible plastic or paper containers should be transferred to a microwave/oven proof container to avoid the possibility of ignition.
- In the event of glass breaking or shattering within the oven, ensure that food is totally free of glass particles. If in doubt, dispose of any food that was in the oven at the time of the breakage.
- Switch off the appliance at the end of all the cooking sessions for that day.

Requirements to be met by operating personnel

- This appliance is not intended for use by persons (including children) with reduced physical sensory or mental capabilities or lack of experience and knowledge unless they have been given supervision or instruction concerning use of the appliance in a safe way and understand the hazards involved. Children shall not play with the appliance. Cleaning and user maintenance shall not be made by children.
- **WARNING:** It is hazardous for anyone other than a competent person to carry out any service or repair operation that involves the removal of any cover which gives protection against exposure to microwave energy. See '*Requirements to be met by personnel, working positions*' on page 39.

Requirements relating to the operating condition of the microwave combination oven

- As with all electrical appliances, it is recommended to have the electrical connections inspected at least once a year.
- This appliance must be grounded. Connect only to a properly grounded outlet. See '*Planning the electrical installation*' on page 49.
- Never remove the external covers of the appliance.

- Never remove any fixed internal parts of the appliance.
- Never tamper with the control panel, door, seals, or any other part of the appliance.
- Never hang dish towels or cloths on any part of the appliance.
- **WARNING:** If the door or door seal is damaged, the appliance must not be operated until it has been repaired by a competent person. See '*Requirements to be met by personnel, working positions*' on page 39.
- The appliance must not be operated without the air filter in place.
- If the supply cord is damaged, it must be replaced by the manufacturer, its service agent or similarly qualified persons in order to avoid a hazard.

Requirements relating to the operating environment of the microwave combination oven

- The minimum height of free space necessary above the top surface of the appliance is 50mm (2").
- The floor adjacent to the appliance may be slippery. Clean up spillages immediately.
- This appliance is not intended for mobile use, such as in marine or vehicle applications.

Cleaning requirements

- The appliance should be cleaned regularly and any food deposits removed.
- The cooking chamber of the appliance and the door seals should be cleaned frequently. Failure to maintain the appliance in a clean condition could lead to deterioration of the surface that could adversely affect the life of the appliance and possibly result in a hazardous situation.
- The appliance should not be cleaned with a water jet.
- Details for cleaning door seals, cavities and adjacent parts are provided in the 'Cleaning procedures' section of this manual.
- The appliance must be disconnected from its power supply during maintenance and when replacing parts. It is not necessary to disconnect the appliance from the power supply during routine daily cleaning tasks.
- When cleaning surfaces of door and oven that come together on closing the door see the instructions on cleaning the door surface in the '*Cleaning procedures*' on page 62 section of this manual.

Emergency instructions

- If smoke is observed: switch off the appliance. Unplug or isolate it from the electrical supply and keep the door closed in order to stifle any flames.

SAVE THESE INSTRUCTIONS

More on this ...

Related topics

▷ Summary of hazards	26
▷ Hazards and safety precautions during cleaning	32
▷ Hazards and safety precautions when moving the appliance	28
▷ Hazards and safety precautions when setting up the appliance	29
▷ Hazards and safety precautions during installing	30
▷ Hazards and safety precautions when preparing appliance for use	31
▷ Hazards and safety precautions when taking the appliance out of service	36
▷ Safety devices	37
▷ Requirements to be met by personnel and working positions	39
▷ Personal protective equipment	40

IMPORTANT

This manual provides technical guidance for technicians who have successfully undertaken a recognized product familiarization and training course run by Merrychef to carry out service/repair tasks to the appliance/s shown on the front cover of this manual which must not be used for any other make or model of appliance.

Please remember that it is wiser not to attempt a service task if you are unsure of being able to complete it competently, quickly, and above all safely.

To avoid injury to yourself or others and to protect the appliance from possible damage, ensure you have read and understand all the relevant instructions and ALWAYS follow the Safety Codes when servicing an oven.

1. Ensure the electrical supply is locked-off to prevent the oven from being inadvertently powered up.

2. Do not leave the oven unattended without the oven panels fitted and keep within sight of other personnel when testing the oven, ensuring persons other than trained engineers are denied access.

3. The minimum number of panels should be removed and the high voltage capacitors must be discharged before working on the oven using a suitably insulated 10 M Ω resistor.

4. Temporary insulation should be used to prevent accidental contact with dangerous conductors.

5. Do not touch any internal wiring or connectors within the oven, whether you believe it is live or not and avoid touching the metalwork (casing, panels, etc) of the oven with your body.

6. Only use electrically rated screwdrivers for adjusting 'Pots' etc., ensuring the tool touches nothing else.

7. Ensure the test equipment is set correctly before use.

8. Test equipment such as meter test leads or clamps must be fitted and removed whilst the unit is dead, for each and every test.

9. Do not undertake functional magnetron testing with the panels of the casing removed.

10. Avoid touching the test equipment, unless necessary for the operation.

11. Upon completion of a service follow the steps for commissioning the oven under the "Commissioning the appliance" section of this manual.

IMPORTANT

▲ CAUTION

Warning to Service Technicians:

Precautions to be observed before and during servicing to avoid possible exposure to excessive microwave energy.

1. Do not operate or allow the oven to be operated with the door open.

2. Make the following safety checks on all ovens to be serviced before activating the magnetron or other microwave source, and make repairs as necessary:
 - Interlock operation.
 - Proper door closing.
 - Seal and sealing surfaces (arcing, wear, and other damage).
 - Damage to or loosening of hinges and latches.
 - Evidence of dropping or abuse.

3. Before turning on microwave power for any service test or inspection within the microwave generating compartments, check the magnetron, wave guide or transmission line, and cavity for proper alignment, integrity and connections.

4. Any defective or misadjusted components in the interlock, monitor, door seal, and microwave generation and transmission systems shall be repaired, replaced, or adjusted by procedures described in this manual before the oven is released to the owner.

5. A microwave leakage check should be performed on each oven prior to release to the owner.



3.2 Intended use of your microwave combination oven

Intended use of your microwave combination oven

The microwave combination oven must only be used for the purposes specified below:

- The microwave combination oven is designed and built solely for cooking different foodstuffs in containers approved by the manufacturer. Microwave, convection and impingement are used for this purpose.
- The microwave combination oven is intended solely for professional, commercial use.

Restrictions on use

Some materials are not allowed to be heated in the microwave combination oven:

- No dry powder or granulated material
- No highly flammable objects with a flash point below 270°C / 518°F, such as highly flammable oils, fats or cloths (kitchen cloths)
- No food in sealed tins or jars

Requirements to be met by personnel

- The microwave combination oven must only be operated and installed by personnel who satisfy specific requirements. Please refer to '*Requirements to be met by personnel, working positions*' on page 39 for the training and qualifications requirements.
- Personnel must be aware of the risks and regulations associated with handling heavy loads.

Requirements relating to the operating condition of the microwave combination oven

- Do not operate the microwave combination oven unless it has been properly transported, set up, installed and placed into operation as indicated in this manual and the person responsible for placing it into operation has confirmed this.
- The microwave combination oven must only be operated when all safety devices and protective equipment are fitted, in working order and fixed properly in place.
- The manufacturer's regulations for operation and servicing of the microwave combination oven must be observed.

Requirements relating to the operating environment of the microwave combination oven

Specified operating environment for the microwave combination oven:

- The ambient temperature lies between +4°C / 40°F and +35°C / 95°F
- Not a toxic or potentially explosive atmosphere
- Dry kitchen floor to reduce the risk of accidents

Specified properties of the installation location:

- No fire alarm, no sprinkler system directly above the appliance
- No flammable materials, gases or liquids above, on, under or in the vicinity of the appliance
- It must be possible to set up the microwave combination oven in the installation position so that it cannot tip over or slide about. The supporting surface must comply with these requirements.

Mandatory restrictions on use:

- The appliance must not be operated outdoors and not be shifted or moved during use.

Cleaning requirements

- Use only cleaning chemicals that have been approved by the manufacturer.
- High-pressure cleaners or water jets must not be used for cleaning.
- The appliance must not be treated with alkali or acid solutions or exposed to acid fumes.

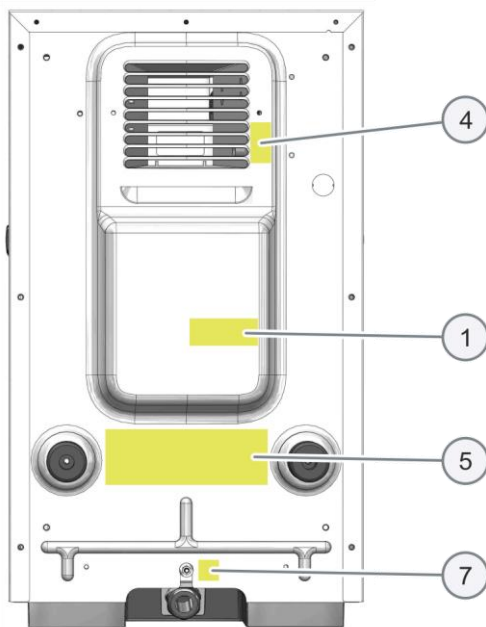
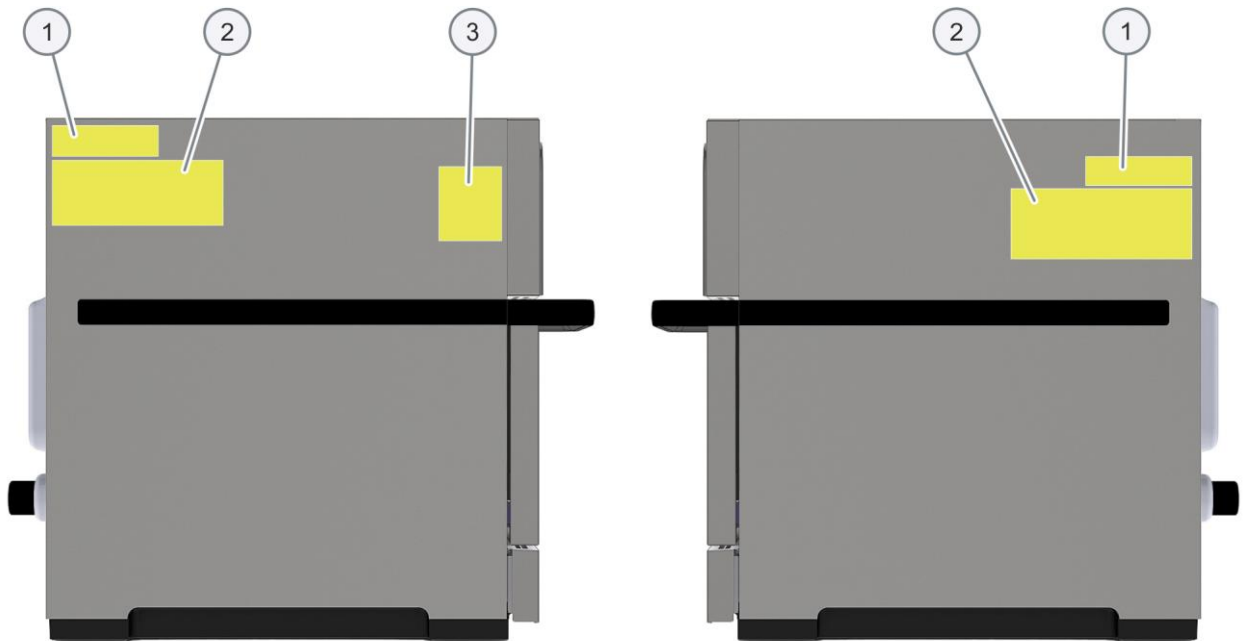

3.3 Warning signs on your microwave combination oven

Warning and safety signs





Mandatory warning signs

The following warning signs / notices must be attached to the microwave combination oven and optional accessories in the area indicated so as to be easily visible at all times.

Area	Warning sign	Description
1		Microwaves warning There is a risk of external and internal burns of body parts following exposure to microwave energy.
2		Electric shock warning There is a risk of electric shock if the appliance is serviced without disconnecting the electrical supply.
3		Fire / electric shock warning There is a risk of fire / electric shock if the appliance is operated without respecting the minimum clearances.
4		Hot surface warning There is a risk of burns from high temperatures inside the cavity and on the inside of the appliance door.
5		Electric shock warning There is a risk of electric shock if the electrical power is not connected to a properly grounded outlet.

Safety symbols

The following safety symbols be attached to the microwave combination oven in the area indicated so as to be easily visible at all times.

Area	Safety symbol	Description
6		Protective Earth (Ground)
7		Equipotential bonding

3.4 Summary of hazards

General rules for dealing with hazards and safety precautions

The microwave combination oven is designed to protect the user from all hazards that can reasonably be avoided by design measures.

The actual purpose of the microwave combination oven, however, means that there are still residual risks; you must therefore take precautions to avoid them. A safety device can provide you with a certain degree of protection against some of these hazards. You must ensure, however, that these safety devices are in place and in working order.

The nature of these residual risks and what effect they have are described below.

Hazard points

The following illustration shows a Merrychef e2s microwave combination oven:

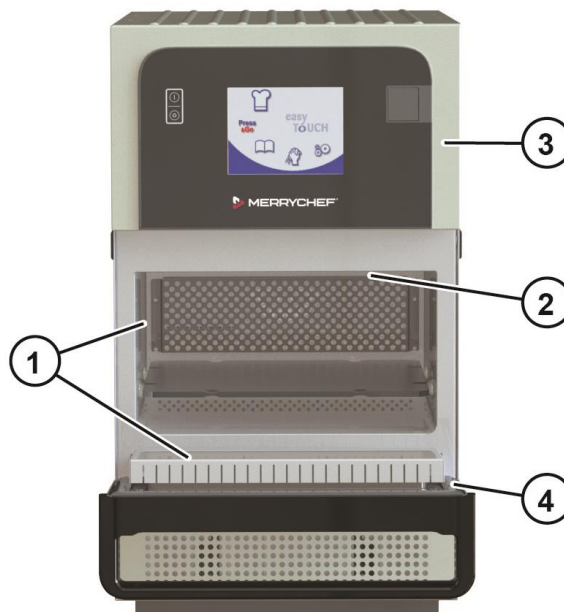

Excessive microwave energy

The microwave combination oven generates microwave energy. An operation with an open or damaged door or cavity can result in external and internal burns of body parts following exposure to microwave energy.

Heat generation (1)

The microwave combination oven becomes hot inside the cavity and on the inside of the appliance door. This poses a risk of burns on hot surfaces inside the microwave combination oven, and also on hot appliance parts, food containers and other accessories used for cooking.

Hot steam / vapour (2)

When cooking food the microwave combination oven may generate hot steam and vapour which escapes when the appliance door is opened and which is removed through the air vents on the rear of the microwave combination oven when the appliance door is closed. This poses a risk of scalding from hot steam when the appliance door is opened. Take particular care when opening the appliance door if the top door edge is below your field of vision.

Hot liquids

Foodstuffs are cooked in the microwave combination oven. These foodstuffs may also be liquid, or liquefy during cooking. This poses a risk of scalding from hot liquids, which may be spilled if not handled properly.

Live components (3)

The microwave combination oven contains live parts. This means a risk from live parts if the cover is not in place.

Contact with cleaning chemicals

The microwave combination oven must be cleaned using special cleaning chemicals. This poses a risk from cleaning chemicals, some of which can cause skin burns.

Parts moving against each other (4)

For various actions, such as opening/shutting the appliance door or cleaning the appliance door, there is the risk that you will crush or cut your hand.

Undercooking of food products

Ensure all food is hot before serving to protect your guests from microbiological contamination of foodstuffs.

3.5 Hazards and safety precautions when moving the appliance

Safety hazard: moving heavy weights

Danger	Where or in what situations does the hazard arise?	Preventive action
Risk of injury from over-stressing your body	When moving the appliance onto and off the moving equipment	<ul style="list-style-type: none"> ▪ Use a forklift truck or pallet truck ▪ Do not exceed safety limits for lifting and carrying ▪ Wear personal protective equipment

Safety hazard: mechanical parts of the appliance

Danger	Where or in what situations does the hazard arise?	Preventive action
Risk of body parts being crushed if the appliance is dropped	When moving the appliance	<ul style="list-style-type: none"> ▪ Use suitable handling gear ▪ Move the appliance slowly and carefully, and secure it against tipping over ▪ Make sure center of gravity is balanced ▪ Avoid jolts
Risk of body parts being crushed if the appliance tips over or falls off	When placing the appliance down on the supporting surface	Always observe the requirements for the supporting surface while setting up the appliance; see ' <i>Requirements for the installation location</i> ' on page 44



3.6 Hazards and safety precautions when setting up the appliance

Safety hazard: moving heavy weights

Danger	Where or in what situations does the hazard arise?	Preventive action
Risk of injury from over-stressing your body	When moving the appliance	<ul style="list-style-type: none"> ▪ Use a forklift truck or pallet truck to place the appliance in the installation position or to move it to a new position ▪ Always use the correct number of persons and observe the limits specified for lifting and carrying when adjusting the appliance position ▪ Observe the local occupational safety regulations ▪ Wear personal protective equipment

Safety hazard: mechanical parts of the appliance

Danger	Where or in what situations does the hazard arise?	Preventive action
Risk of body parts being crushed if the appliance is dropped	When lifting the appliance	<ul style="list-style-type: none"> ▪ Make sure center of gravity is balanced ▪ Avoid jolts
Risk of cuts from sharp edges	When handling sheet-metal parts	<ul style="list-style-type: none"> ▪ Exercise caution when performing these tasks ▪ Wear personal protective equipment

3.7 Hazards and safety precautions during installing

Safety hazard: electrical power

Danger	Where or in what situations does the hazard arise?	Preventive action
Risk of electric shock from live parts	<ul style="list-style-type: none"> ▪ Under covers ▪ Under the operating panel ▪ Along the mains power lead 	<ul style="list-style-type: none"> ▪ Work on the electrical system must only be performed by qualified electricians from an authorised service company ▪ Professional working <p>Ensure that all electrical connections are in perfect condition and fixed securely before putting the appliance into use</p>
	On the appliance and on adjacent metal parts	Before preparing the appliance for use, make sure that the appliance is connected to an equipotential bonding system (EU).

Safety hazard: mechanical parts of the appliance

Danger	Where or in what situations does the hazard arise?	Preventive action
Trapping fingers or body	When opening or closing the door	Use the handle and avoid the door hinges

3.8 Hazards and safety precautions when preparing appliance for use

Safety hazard: electrical power

Danger	Where or in what situations does the hazard arise?	Preventive action
Risk of electric shock from live parts	<ul style="list-style-type: none"> ▪ Under covers ▪ Under the operating panel ▪ Along the mains power lead 	<ul style="list-style-type: none"> ▪ Work on the electrical system must only be performed by qualified electricians from an authorised service company ▪ Professional working <p>Ensure that all electrical connections are in perfect condition and fixed securely before putting the appliance into use</p>
	On the appliance and on adjacent metal parts	Before preparing the appliance for use, make sure that the appliance is connected to an equipotential bonding system (EU).

Additional safety hazards when preparing appliance for use

When preparing the appliance for use, read and follow the safety information given in this chapter and also the following sections in the chapter '*For your safety*' on page 17 in the user manual:

- 'Hazards and safety precautions during operation'
- 'Hazards and safety precautions during cleaning'

3.9 Hazards and safety precautions during cleaning

Safety hazard: cleaning chemicals

Danger	Where or in what situations does the hazard arise?	Preventive action
Risk of chemical burns or irritation to skin, eyes and respiratory system from contact with cleaning chemicals and their fumes	For all cleaning actions	<ul style="list-style-type: none"> ▪ Do not let cleaning chemicals come into contact with your skin or eyes ▪ Do not heat up the appliance if there are cleaning chemicals inside ▪ Never spray cleaning chemicals into the cavity ▪ Do not breathe in spray ▪ Wear personal protective equipment
	When corrosive cleaning chemicals are used	Only use those cleaning chemicals specified under 'Cleaning agents' on page 64.

Safety hazard: contamination of foodstuffs

Danger	Where or in what situations does the hazard arise?	Preventive action
Risk of food contamination from cleaning chemicals	If the cavity has not been washed off properly after cleaning.	Wash off the cavity using a clean cloth and plenty of clean warm water, then wipe with a soft cloth or paper towel.

Safety hazard: heat

Danger	Where or in what situations does the hazard arise?	Preventive action
A risk of burns from hot surfaces	Inside the entire cavity, including all parts that are or were inside during cooking, such as <ul style="list-style-type: none"> ▪ Racks ▪ Containers, baking sheets, shelf grills etc. On the inside of the appliance door	<ul style="list-style-type: none"> ▪ Before starting cleaning tasks, wait until the cavity has cooled to below 50°C / 122°F or use the 'cool down' function to cool the cavity ▪ Wear specified protective clothing, in particular protective gloves
Risk of scalding from hot steam if water is sprayed into the hot cavity	In the entire cavity	<ul style="list-style-type: none"> ▪ Before starting cleaning work, wait until the cavity has cooled to below 50°C / 122°F or use the 'Cool Down' function to cool the cavity ▪ Wear specified protective clothing, in particular protective gloves
Risk of scalding from hot steam	In front of the appliance if the cavity is being cooled by the 'Cool Down' function	<ul style="list-style-type: none"> ▪ Step back from the appliance to avoid the hot steam and vapour escaping through the open appliance door ▪ Do not put your head inside the cavity

Safety hazard: moving appliances supported on a wheeled base

Danger	Where or in what situations does the hazard arise?	Preventive action
All specified hazards	While appliances are being moved on a wheeled platform	When moving the microwave combination oven, take care not to wheel over the electrical supply cables
Risk of crushing of body parts	While appliances are being moved on a wheeled platform	Watch out for the connecting cables
Risk of scalding from hot liquid food	While appliances are being moved on a wheeled platform	Always remove any food from the appliance before moving it
Risk of electric shock from live parts	While appliances are being moved on a wheeled platform	Watch out for connected electrical cables
Risk of tripping from exposed cables	While cleaning behind appliances when pulled forward	Exercise caution when performing this action

Safety hazard: electrical power

Danger	Where or in what situations does the hazard arise?	Preventive action
Risk of electric shock caused by a short-circuit	If the appliance comes into contact with water	<ul style="list-style-type: none"> ▪ Do not wash down the outer case with water ▪ Always keep the USB cover closed during cleaning
Risk of electric shock from live parts	If appliances on wheeled stands start moving unintentionally and the power supply is pulled off	<ul style="list-style-type: none"> ▪ When operating the appliances, always engage the parking brake on the wheels ▪ Check that wheel brakes are on before operation each day

Safety hazard: mechanical parts of the appliance

Danger	Where or in what situations does the hazard arise?	Preventive action
Risk of crushing to hands and pinching of fingers	When opening and closing the appliance door	Exercise caution when performing this action

3.10 Hazards and safety precautions during servicing and repair

Safety hazard: heat

Danger	Where or in what situations does the hazard arise?	Preventive action
A risk of burns from hot surfaces	<p>Inside the entire cavity, including all parts that are or were inside during cooking, such as</p> <ul style="list-style-type: none"> ▪ Racks ▪ Containers, baking sheets, shelf grills etc. <p>On the inside of the appliance door</p>	<ul style="list-style-type: none"> ▪ Before starting cleaning tasks, wait until the cavity has cooled to below 50°C / 122°F or use the 'cool down' function to cool the cavity ▪ Wear specified protective clothing, in particular protective gloves

Safety hazard: electrical power

Danger	Where or in what situations does the hazard arise?	Preventive action
Risk of electric shock from live parts	<ul style="list-style-type: none"> ▪ Under covers ▪ Under the control panel 	<p>Work on the electrical system must only be performed by qualified electricians from an authorized customer service company</p> <p>Before removing the covers:</p> <ul style="list-style-type: none"> ▪ Switch off all connections to the power supply ▪ Take protective measures at every power switch to ensure that the power cannot be switched on again. ▪ Wait 15 minutes to allow the DC bus capacitors to discharge ▪ Make sure that the appliance is de-energized <p>Make sure that the electrical connections are intact and fixed securely before plugging the appliance back into the power supply.</p>
	<ul style="list-style-type: none"> ▪ On the appliance and on adjacent metal parts ▪ On the appliance and on adjacent metallic accessories 	<p>Before putting the appliance back into use, make sure that the appliance, including all metallic accessories, is connected to an equipotential bonding system.</p>

Safety hazard: mechanical parts of the appliance

Danger	Where or in what situations does the hazard arise?	Preventive action
Risk of cuts from sharp edges	<p>During servicing work</p> <p>When handling sheet-metal parts</p>	<ul style="list-style-type: none"> ▪ Exercise caution when performing this action ▪ Wear personal protective equipment
Risk of body parts being crushed if the appliance tips over or falls off	When the appliance is being moved e.g. to gain better access to the connections	Always observe the requirements for the supporting surface

Safety hazard: moving heavy weights

Danger	Where or in what situations does the hazard arise?	Preventive action
Risk of injury from over-stressing your body	When moving the appliance	<ul style="list-style-type: none"> ▪ Use a forklift truck or pallet truck to place the appliance in the installation position or to move it to a new position ▪ Always use the correct number of persons and observe the limits specified for lifting and carrying when adjusting the appliance position ▪ Observe the local occupational safety regulations ▪ Wear personal protective equipment

Safety hazard: moving appliances supported on a wheeled base

Danger	Where or in what situations does the hazard arise?	Preventive action
Risk of crushing of body parts Risk of hands and feet being pinched Risk of electric shock from live parts	While appliances are being moved on a wheeled platform	<ul style="list-style-type: none"> ▪ Disconnect the appliance from the electrical supply before moving it ▪ When servicing the appliances, always engage the parking brake on the wheels

Safety hazard: smoke or fire

Danger	Where or in what situations does the hazard arise?	Preventive action
Risk of fire / smoke from defective electrical components or wrong electrical connections.	If one of the electrical components is defect, for example due to a short circuit, or if the internal wiring is refitted incorrectly when servicing/repairing the oven.	<ul style="list-style-type: none"> ▪ Never use electrical spare components which failed in a dedicated test or which bear visible damages. ▪ Carefully refit electrical connections using the wiring diagrams provided in this manual.



3.11 Hazards and safety precautions when taking the appliance out of service

Safety hazard: electrical power

Danger	Where or in what situations does the hazard arise?	Preventive action
Risk of electric shock from live parts	<ul style="list-style-type: none"> ▪ Under covers ▪ Under the operating panel 	<ul style="list-style-type: none"> ▪ Work on the electrical system must only be performed by qualified electricians from an authorized customer service company ▪ Professional working

Safety hazard: moving heavy weights

Danger	Where or in what situations does the hazard arise?	Preventive action
Risk of injury from over-stressing your body	When moving the appliance onto and off the moving equipment	<ul style="list-style-type: none"> ▪ Use a forklift truck or pallet truck ▪ Do not exceed safety limits for lifting and carrying ▪ Wear personal protective equipment

Safety hazard: mechanical parts of the appliance

Danger	Where or in what situations does the hazard arise?	Preventive action
Risk of body parts being crushed if the appliance tips over or falls off	When the appliance is being moved e.g. to gain better access to the connections	Always observe the requirements for the supporting surface when taking the appliance out of service; see ' <i>Requirements for the installation site</i> ' on page 44
Risk of slipping on damp kitchen floor	In front of the appliance	Ensure that the floor around the appliance is dry at all times

3.12 Safety devices

Meaning

The microwave combination oven has a number of safety devices to protect the user from hazards. It is absolutely essential that all safety devices are fitted and in working order when operating the appliance.

Position and function

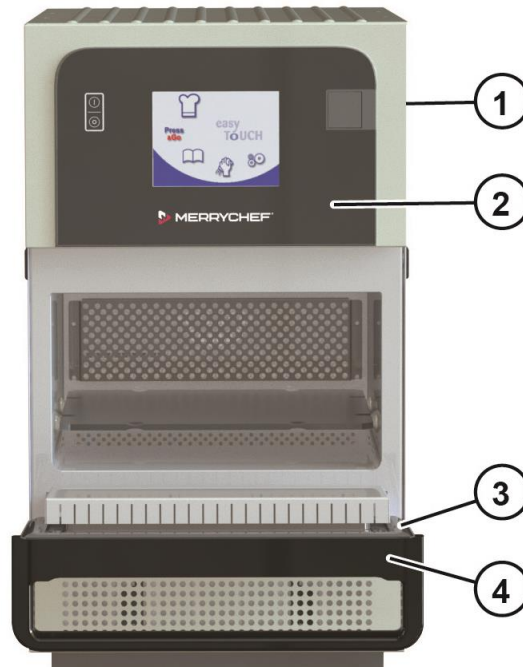

Item	Safety device	Function	Check
1	Covers can only be removed using a tool	<ul style="list-style-type: none"> Prevents live parts from being touched accidentally Prevents access to the moving fan from the wiring compartment 	Check that the covers are in place
2	Operating panel can only be removed using a tool	Prevents live parts from being touched accidentally	Ensure that the operating panel is in place
3	Door seal	Protects the user and outside environment from microwave energy leaking from the cavity	Check the door seal regularly for signs of damage and replace it if required.
4	Appliance door	Protects the user and outside environment from hot steam and microwave energy	Check the door regularly for damage and replace it if required
5 (no picture)	Door interlocks: Electric door sensor for appliance door	Ensures that the microwave generation system cannot be powered when the door is open.	Check door switch: Action: <ul style="list-style-type: none"> Open the appliance door fully Press Start Result: Door open warning message

Item	Safety device	Function	Check
6 (no picture, installed by customer)	Disconnection device	<ul style="list-style-type: none"> ▪ Installed by the customer close to the appliance; easily visible and accessible, 1- or 3-pole action, minimum contact separation 3 mm. ▪ Used to disconnect the appliance from the power supply during cleaning, repair and servicing work and in case of danger 	Action: <ul style="list-style-type: none"> ▪ Trip the disconnection device
7 (no picture)	Internal fuses	Prevent faulty components from drawing too much current and causing potential fire hazard.	Ensure that the internal fuses are correctly rated

3.13 Requirements to be met by personnel and working positions

Requirements to be met by operating personnel

Personnel	Qualifications	Tasks
Service technician	<ul style="list-style-type: none">▪ Is an authorized service agent▪ Has relevant technical training▪ Is trained in the particular appliance▪ Knows the regulations associated with handling heavy loads	All servicing and repair work

Working positions during servicing and repairs

The service area for staff during servicing and repair work is the area around the appliance.

If it is not possible to obtain full access to all sides of the appliance move it to a better location following all manual handling recommendations.

3.14 Personal protective equipment

Moving and setting up the appliance

Activity	Materials used	Personal protective equipment
<ul style="list-style-type: none"> Conveying within the establishment Setting up the appliance on a work surface, stand or in a stacking kit Setting up the appliance in the installation location 	<ul style="list-style-type: none"> Suitable lifting gear Forklift truck or pallet truck 	<ul style="list-style-type: none"> Protective gloves Safety boots Hard hat (e.g. when heavy loads are being lifted, working overhead, ...)

Installation, preparing for first-time use and taking out of service

Activity	Materials used	Personal protective equipment
Installing and removing (taking out of operation) the electrical connection	Tools and equipment depending on the task	Work wear and personal protective equipment depending on the job that needs doing as specified in national regulations
<ul style="list-style-type: none"> Preparing the appliance for first-time use Instructing the user 	Tools and equipment depending on the task	Work wear as specified in country-specific standards and directives for kitchen work, in particular: <ul style="list-style-type: none"> Protective clothing Heat protective gloves (compliant with EN 407 in European Union) Safety boots
Dismantling the appliance (taking out of operation)	<ul style="list-style-type: none"> Suitable lifting gear Forklift truck or pallet truck 	<ul style="list-style-type: none"> Protective gloves Safety boots Hard hat (e.g. when heavy loads are being lifted, working overhead)

Operation

Activity	Materials used	Personal protective equipment
Loading / removing food	None	Work wear as specified in country-specific standards and directives for kitchen work, in particular: <ul style="list-style-type: none"> Protective clothing Heat protective gloves (compliant with EN 407 in European Union) Safety boots
Removing and fitting parts	Tools and equipment depend on the task	Work wear as specified in country-specific standards and directives for kitchen work, in particular: <ul style="list-style-type: none"> Protective clothing Heat protective gloves (compliant with EN 407 in European Union) Safety boots

Cleaning

Activity	Materials used	Personal protective equipment
<ul style="list-style-type: none"> Cleaning the cavity by hand Handling spray bottles 	<ul style="list-style-type: none"> Cleaning chemicals approved by the manufacturer 	Items of protection equipment, depending on cleaning chemical being used:

Activity	Materials used	Personal protective equipment
	<ul style="list-style-type: none"> ▪ Protective chemicals approved by the manufacturer 	<ul style="list-style-type: none"> ▪ Breathing mask ▪ Safety goggles ▪ Protective gloves ▪ Protective clothing/apron <p>The EC safety datasheet for the relevant cleaning chemical contains a more precise specification of these items. An up-to-date copy can be obtained from the manufacturer.</p> <p>Refer to the label on the cleaning chemical concerned.</p>
Cleaning components and accessories according to relevant instructions	Common household detergent: mild on skin, alkali-free, pH-neutral and odourless	Follow the instructions given by the manufacturer of the cleaning chemical you are using
Cleaning the outside of the appliance case	Common household stainless steel cleaner or hard surface cleaner	Follow the instructions given by the manufacturer of the cleaning chemical you are using

Repairs

Activity	Protection equipment
All repair work	Work wear and personal protective equipment depending on the job that needs doing as specified in national regulations

4 Setting up the appliance

Purpose of this chapter

This chapter provides information on how to set up your appliance.

This chapter is intended for the user and for a qualified member of staff from an authorized service company.

Contents

This chapter contains the following topics:

	Page
Safe working when setting up the appliance	43
Requirements for the installation location	44
Mounting the appliance on a work surface	46



4.1 Safe working when setting up the appliance

For your safety

Before starting work, familiarize yourself with the hazards described in '*Hazards and safety precautions when setting up the appliance*' on page 29.

Eligibility of personnel for setting up the appliance

Personnel eligible for setting up the appliance:

- Only qualified personnel from an authorized service company are permitted to set up the appliance.

Regulations for setting up the appliance

Local and national standards and regulations relating to workplaces in catering kitchens must be observed.

The rules and regulations of the local authorities and supply companies that apply to the installation location concerned must be observed.

Personal protective equipment

Wear the following personal protective equipment specified in the section '*Personal protective equipment*' on page 40 of the '*For your safety*' chapter for the relevant tasks.

Moving heavy loads

⚠WARNING

Risk of injury from lifting incorrectly

When lifting the appliance, the weight of the appliance may lead to injuries, especially in the area of the torso.

- ▷ Use a forklift truck or pallet truck to place the appliance in the installation position or to move it to a new position.
- ▷ When shifting the appliance into the correct position, use enough people for the weight of the appliance when lifting it (value depending on age and gender). Observe the local occupational safety regulations.
- ▷ Wear personal protective equipment.

Unsuitable supporting surface

⚠WARNING

Risk of crushing if the appliance tips over or falls off

Body parts can be crushed if the appliance tips over or falls off.

- ▷ Make sure that the appliance is never placed on an unsuitable supporting surface.

4.2 Requirements for the installation location

Meaning

This section contains information to help you choose a suitable installation location for the microwave combination oven. Inspect the intended installation location carefully to ensure it is suitable before taking the appliance there and starting the installation.

Rules for setting up the appliance safely

To prevent hazards that arise from the installation site and environment of the appliances, the following rules must be observed:

- It must be possible to comply with the operating conditions. For operating conditions, see '*Requirements relating to the operating environment of the microwave combination oven*' on page 23.
- There is a risk of fire from the heat emitted from hot surfaces. Therefore flammable materials, gases or liquids must not be located near, on or below the appliance. When choosing where to install the appliance it is essential to remember this requirement together with the minimum space required for the appliance.
- Heat sources in the vicinity must lie at a minimum distance of 500 mm / 20 in.
- The appliance must be installed so that there is absolutely no possibility that liquid from the appliance or liquid coming from cooking processes can reach deep-fat fryers or appliances that use hot, uncovered fat. Deep-fat fryers or appliances that use hot, uncovered fat that are located in the vicinity must lie at a minimum distance of 500 mm / 20 in.
- The appliance must not be installed directly under a fire alarm or sprinkler system. Fire alarm installations and sprinkler systems must be set up to handle the level of steam and vapour expected to escape from the appliance when the door is opened.
- It must be possible to set up the supporting structure for the appliance (work surface, stand or stacking kit) in the installation position so that it cannot tip over or slide about. The supporting surface must satisfy the requirements listed below.
- Vibrations must generally be avoided when using wheeled oven stands or wheeled stacking kits.

Requirements for the supporting surface

The supporting surface must have the following properties:

- The supporting surface must be flat and level.
- The supporting surface must be able to bear the in-use weight of the appliance plus the weight of the structure supporting the appliance.
- The structure supporting the appliance (work surface or stand) must be able to bear the in-use weight of the appliance.

Empty weight of appliance

e2s High Power version	[lbs]	134	[kg]	61.0
e2s Standard Power version	[lbs]	114	[kg]	51.7

Actual space requirements

Far more room than the specified minimum space requirement is needed in front of the appliances to operate the microwave combination ovens safely, in particular to handle hot food safely.

Larger wall gaps are generally recommended to provide access for servicing.

In the installation location, the following parts must not be covered, adjusted or blocked (see also '*Design and function of the microwave combination oven*' on page 14):

- Air vent on the rear of the appliance
- Air filter at the front of the appliance

Minimum space required

4 Setting up the appliance

The following diagram and table show the space required for the appliance for different installation and operating situations. They also show the minimum horizontal distances from adjacent walls and surfaces. The safety clearance on the top must always be complied with.

Meaning		Space required			
A	Safety clearance from the top	[in]	2	[mm]	50
B	Depth requirement, appliance door open at 90°	[in]	12.2	[mm]	310
	Safety clearance on left-/right-hand side / at rear	[in]	0	[mm]	0

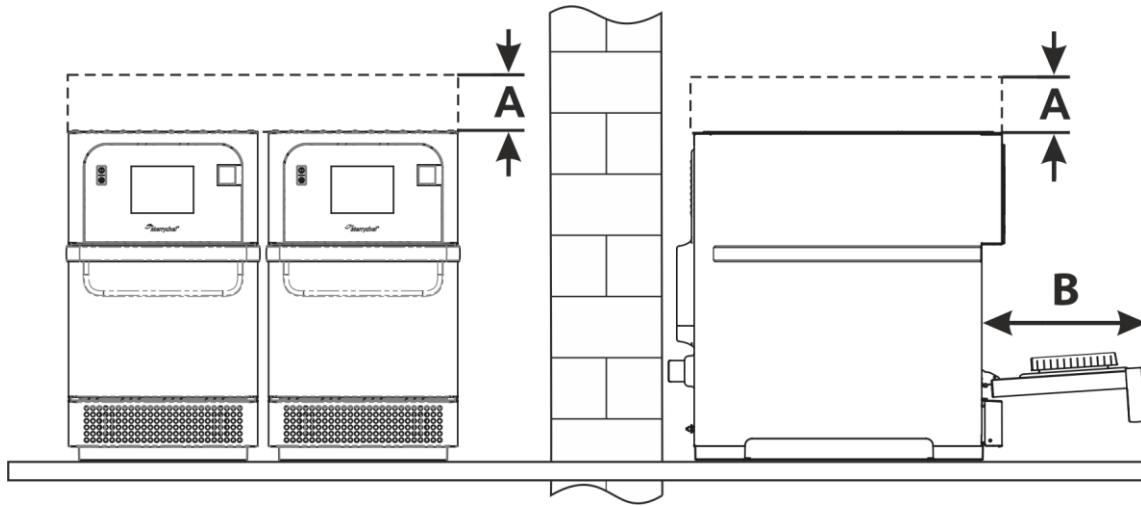

4.3 Mounting the appliance on a work surface

Rules for setting up the appliance safely

Observe the following rules to ensure that the appliance is installed in a stable situation:

- It must be possible to set up the work surface in the installation position so that it cannot tip over or slide about. The supporting surface must comply with the requirements.
- The work top must have a non-slip surface.

5 Installation

Purpose of this chapter

This chapter explains how to connect your microwave combination oven to the electrical supply.

Contents

This chapter contains the following topics:

	Page
Safe working during electrical installation	48
Planning the electrical installation	49
Electrical installation requirements	51

5.1 Safe working during electrical installation

For your safety

Before starting work, familiarize yourself with the hazards described in '*Hazards and safety precautions during installation*' on page 30.

Eligibility of personnel for the electrical installation

Only electricians qualified under the terms of EN 50110-1 and from an authorized service company are permitted to perform work on electrical equipment.

Regulations for the electrical installation

Observe the following requirement to prevent hazards caused by faulty electrical connections:

- The electrical supply must be connected in accordance with applicable local and national regulations and regulations of the professional associations and of the relevant power supply company.

Personal protective equipment

Wear the personal protective equipment specified in the section '*Personal protective equipment*' on page 40 of the '*For your safety*' chapter for the relevant tasks.

Live components

⚠ DANGER

Risk of electric shock from live parts

When the appliance is not connected to an equipotential bonding system, there is a risk of electric shock from touching live parts.

- ▷ Make sure that any work on the electrical system is performed solely by a qualified electrician from an authorized service company.
- ▷ Make sure that the electrical connections are intact and connected securely before putting the appliance into use.
- ▷ Before preparing the appliance for use, make sure that the appliance, including all metallic accessories, is connected to an equipotential bonding system.

5.2 Planning the electrical installation

Meaning

It is crucial to the safe and reliable operation of the appliance that the electrical system is installed carefully and correctly. All the rules and regulations listed here, and the described procedure, must be strictly followed.

Rules for safe electrical installation of the appliances

Observe the following rules to prevent hazards caused by faulty electrical connections:

- The electrical supply must be connected in accordance with applicable local regulations of the professional associations and of the relevant power supply company.
- The case of the appliance must be grounded in a suitable manner and connected to an equipotential bonding system.
- If two microwave combination ovens are installed in a stacking kit, both cases of the appliances and the stacking kit itself must be grounded in a suitable manner and connected to an equipotential bonding system.
- For microwave combination ovens on a wheeled platform, the length of the mains power lead must accommodate the degree of movement allowed to the appliance by the retaining device on the wheeled platform. When moving the assembly (platform plus appliance), never place the mains power lead under tension.
- All electrical connections must be checked when the appliance is prepared for first-time use to ensure cables are laid correctly and connections are made properly.

Equipment provided by customer and electrical installation regulations

The table below shows what equipment must be provided by the customer and what regulations must be observed when connecting the appliance.

Equipment	Regulations
Fuse	Fuse protection and connection of the appliance must comply with local regulations and national installation requirements.
Equipotential bonding	The appliance must be incorporated in an equipotential bonding system. Equipotential bonding: electrical connection that ensures that the frames of electrical equipment and any external conductive components are at an equal (or practically equal) potential.
Residual-current device (RCD)	The installation regulations require protection by a residual-current device (RCD). Suitable residual-current devices meeting the relevant national regulations must be used. If the installation includes more than one appliance, one residual-current device must be provided for each appliance.
Disconnection device	An easily accessible all-pole disconnection device with a minimum contact separation of 3 mm must be installed close to the appliance. The appliance must be connected via this disconnection device. The disconnection device is used to disconnect the appliance from the electrical supply for cleaning, repair and installation work.

Fitted frequency-converter

The appliance is fitted with one frequency converter (FC) and an EMC mains input filter. These devices may result in a leakage current of more than 3.5 mA per FC drive. Use a suitable RCD for the rated voltage.

Properties of the residual-current device

The residual-current device (RCD) must have the following properties:

- Filter for filtering out RF currents
- “Time delayed” trip characteristic for RCD devices with trip threshold $>30\text{mA}$: prevents RCD being tripped by charging currents of capacitors and parasitic capacitances when appliance is switched on.
- “Leakage current protection, type SI” trip characteristic for RCD devices with trip threshold $\geq 30\text{mA}$: insensitive to nuisance tripping.

5.3 Electrical installation requirements

Circuit Breakers

Establishments with standard (Type 'B') circuit breakers are sensitive to 'surges' which occur on switching on freezers, refrigerators and other catering equipment, including microwave combination ovens. Because of this, a Type 'D' circuit breaker (designed specifically for this type of equipment) must be fitted. An individual, suitably rated circuit breaker should be fitted for each appliance installed.

Low impedance electrical supply

This commercial combination microwave oven complies with EN 61000-3-11. However, when connecting sensitive equipment to the same supply as the appliance, the user should determine in consultation with the supply authority, if necessary, that a low impedance supply is used.

Electrical supply

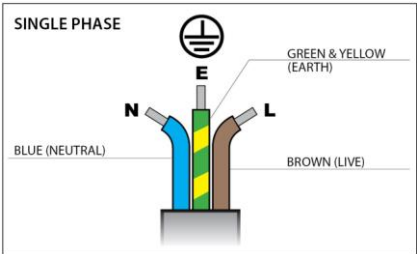
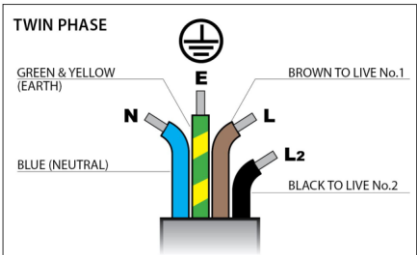
Illustration	Phase	Meaning
	Single Phase	<p>UK models are fitted with a blue 32 A plug to IEC 60309 (EN 60309). The circuit breakers should be rated at 32 A for 32 A and 16 A for 16 A plug configurations and be Time Delay, Motor Start Type (European Type D). UK 13 A models are fitted with a moulded plug to BS1363, fused at 13A. EU 16 A models are fitted with a moulded plug to CEE 7/7 (Type F Schuko) rated at 16 A.</p>
	Twin Phase	<p>Twin Phase models should be connected as shown. Circuit Breakers should be rated at 20 A or higher per phase and be Time Delay, Motor Start Type (European Type D).</p>

Equipotential bonding



An Equipotential Bonding point is provided on the rear panel of the appliance for independent Earth (GND) connection.

Phase loading diagram

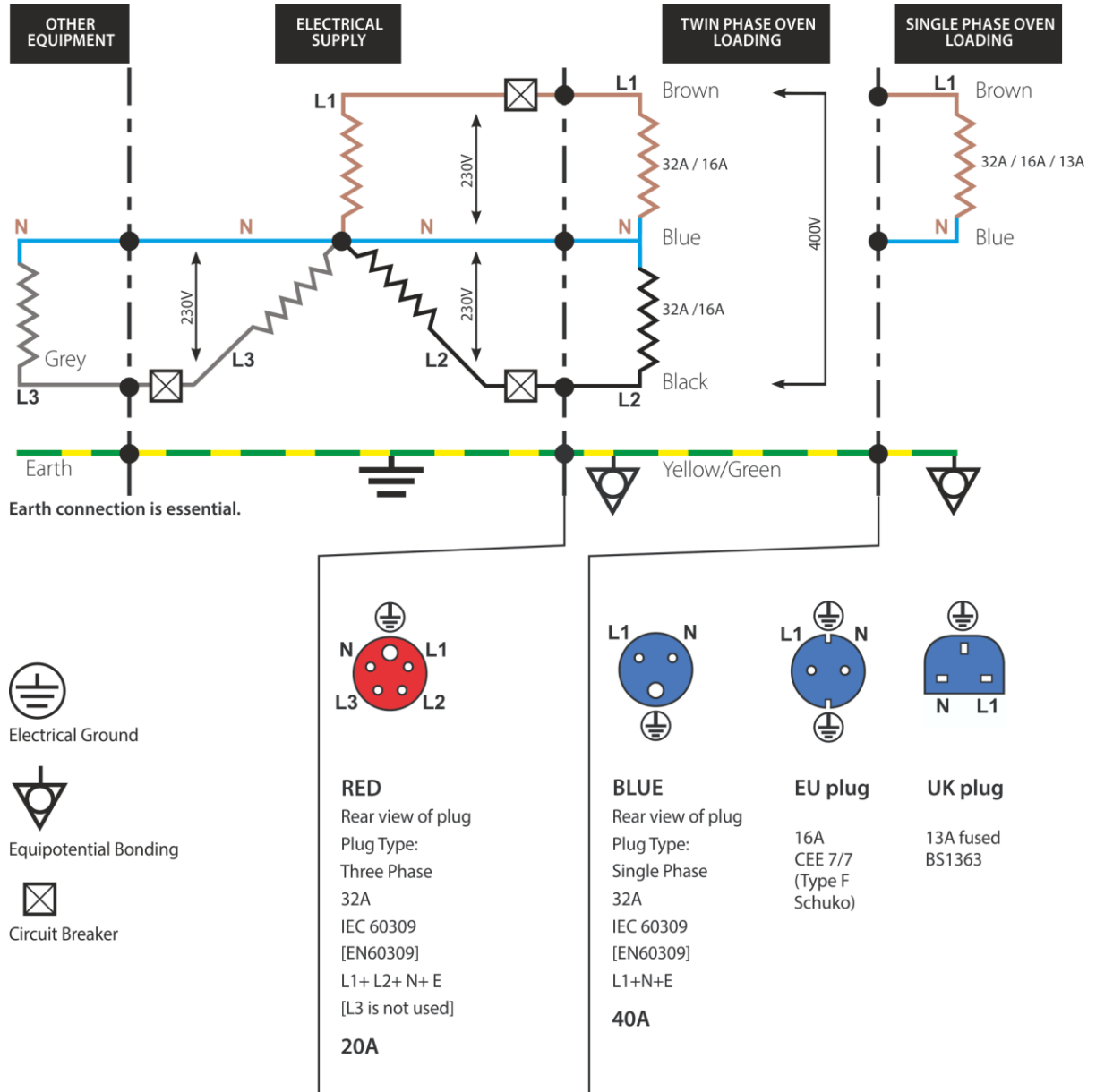

Explanation to phase loading diagram

Phase Loading

Loading per phase is not equal. Therefore it is recommended to connect other electrical equipment to L3+N.

6 Preparing the appliance for use

Purpose of this chapter

This chapter shows you how to put the microwave combination oven into operation and how to cook.

Contents

This chapter contains the following topics:

	Page
Safe working when preparing the appliance for use	54
Procedure for preparing the appliance for use	56
Main menu screen	58
The keyboard screen	59
Using a USB stick	60



6.1 Safe working when preparing the appliance for use

For your safety when preparing the appliance for use

Before starting work, make sure that you are familiar with the hazards described under '*Hazards and safety precautions when preparing appliance for use*' on page 31 and in the chapter '*For your safety*' in the user manual.

Eligibility of personnel preparing the appliance for use and taking it out of service

Work performed on the appliance while preparing it for use is performed in special operating circumstances (e.g. with safety covers removed) or includes activities that require personnel to have relevant qualifications and appliance-specific knowledge that exceed the requirements for operating personnel.

The following requirements must be met by personnel:

- They are qualified employees of an authorized service company.
- Personnel have relevant training as a service engineer.
- Personnel have training specific to the appliance.

Personal protective equipment for preparing the appliance for use

Wear the personal protective equipment specified in the section '*Personal protective equipment*' on page 40 of the '*For your safety*' chapter for the relevant tasks.

Rules for safe operation of the appliance

To avoid hazards, the following rules must be observed during operation:

- The exhaust vent on the rear of the appliance, and the ventilation holes in the front of the appliance base must not be covered, obstructed or blocked.
- Ensure all appropriate accessories are fitted.

To avoid hazards, the following rules must be observed when operating appliances positioned on a wheeled supporting structure:

- The parking brakes on the front wheels must always be engaged when operating the appliances.
- Check that the wheel brakes are on before operation each day.

Live components

⚠ DANGER

Risk of electric shock from live parts

When the appliance is not connected to an equipotential bonding system, there is a risk of electric shock from touching live parts.

- ▷ Make sure that any work on the electrical system is performed solely by a qualified electrician from an authorized service company.
- ▷ Before preparing the appliance for use, make sure that the appliance, including all metallic accessories, is connected to an equipotential bonding system.

Hot surfaces

⚠ WARNING

Risk of burns from high temperatures inside the cavity and on the inside of the appliance door

- ▷ You may get burnt if you touch any of the interior parts of the cooking chamber, the inside of the appliance door or any parts that were inside the oven during cooking.
- ▷ Wear personal protective equipment.

Hot steam / vapour

▲WARNING

Risk of scalding from hot steam and vapour

- ▷ When opening the door, always be cautious of escaping hot steam and vapour which can cause scalding to face, hands, feet and legs.
- ▷ When you are cooling the cavity using the 'cool down' function, step back from the appliance to avoid the hot steam and vapour escaping through the open door.

Excessive microwave energy

▲WARNING

Risk of burns from excessive microwave energy

PRECAUTIONS TO AVOID POSSIBLE EXPOSURE TO EXCESSIVE MICROWAVE ENERGY

- ▷ Do not attempt to operate this oven with the door open since open-door operation can result in harmful exposure to microwave energy. It is important not to defeat or tamper with the safety interlocks.
- ▷ Do not place any object between the oven front face and the appliance door or allow soil or cleaner residue to accumulate on sealing surfaces.
- ▷ Do not operate the oven if it is damaged. It is particularly important that the oven door closes properly and that there is no damage to the (1) door (bent), (2) hinges, (3) door seals and sealing surfaces.
- ▷ The oven should not be adjusted or repaired by anyone except properly qualified service personnel.

Radio interference

NOTICE

This is a Class A product. In a domestic environment this product may cause radio interference in which case the user may be required to take adequate measures.

Reduce or eliminate interference to radio, television, or other electrical appliances by doing the following:

- Place electrical appliances as far away from the microwave combination oven as possible.
- Use a properly installed antenna on radio, television, etc. to obtain stronger signal reception.

6.2 Procedure for preparing the appliance for use

Checks prior to preparing the appliance for use

Before preparing the microwave combination oven for use use the checklists below to make sure that all important requirements are met. The appliance must not be put into operation until all the specified requirements are met.

Checklist for moving, setting up and installing the appliance:

- Cardboard packaging and transport securing devices etc. have been removed completely from the appliance.
- The appliance has no signs of damage.
- The appliance has been set up so that it cannot slide about or tip over; the requirements for the installation position and the area around the appliance have been met.
- The appliance is installed in accordance with the installation regulations.

Checklist for safety devices and warnings:





- All safety devices are in their designated position, are working correctly and are secured properly in place.
- All warning signs are in their designated position.

Suitable cooking utensils

Check the manufacturer's instructions and temperature rating to determine the suitability of individual containers or utensils using each of the cooking functions. The following chart provides general guidelines:

Cooking utensils	Permitted	Notice
Heat resistant containers		
Toughened glass	YES	
Compatible vitreous ceramics	YES	Do not use items with metallic decoration.
Earthenware (porcelain, crockery, china, etc.)	YES	
Metallic and foil trays		
Any metal or foil containers	NO	
Plastic containers		
Dual-ovenable plastic containers	YES	Use only plastic containers approved by the manufacturer.
Disposables		
Combustibles (paper, card, etc.)	YES	Use only combustibles approved by the manufacturer.
Other utensils		
Tie tags	NO	
Cutlery	NO	No kitchen utensil should be left in a food product while it is cooking in the cavity.
Temperature probes	NO	

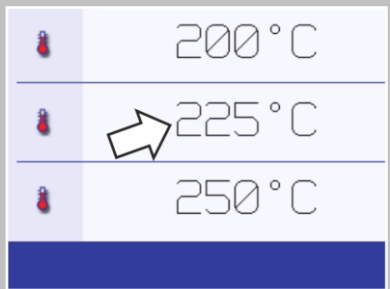
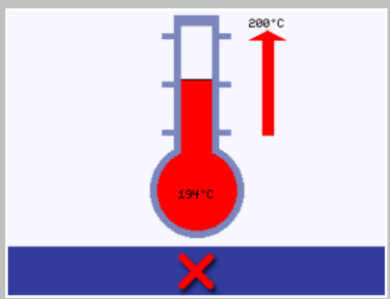
Start up

- | | | |
|----|---|---|
| 1. |  | <p>Make all the relevant safety checks and ensure the appliance is clean and empty.
Then switch the appliance ON.</p> |
| 2. |  | <p>The easyTouch® screen illuminates with the display briefly showing the serial number and appliance data.
If required, to keep the data on the screen, lightly tap the screen once to freeze the display. Tap again to continue.</p> |
| 3. |  | <p>When the appliance is set up with two or more preheating temperatures a choice is displayed.
Scroll arrows at the bottom of the screen indicate that there are more temperature choices not shown on the screen.
If necessary, use the scroll arrows. Then select the temperature required to start preheating the cavity.</p> |
| 4. |  | <p>During preheating the display shows the progress as the cavity heats up to the set temperature.
To stop the cavity heating up touch the red 'X' symbol at the bottom of the screen.</p> |
| 5. |  | <p>The appliance is ready to use when the 'cookbook' is displayed.</p> |

Customer guidance and instruction





Instruct the user regarding all safety-related functions and devices.
Instruct the user in how to operate the appliance.

6.3 Main menu screen

Appearance



The buttons and what they do

Button	Meaning	Function
	Development Mode	'Development Mode' enables multistage cooking profiles to be developed, then stored under a name and symbol for reuse.
	Press&Go	'Press&Go' allows quick access to use the cooking profiles that are already stored.
	Cookbook	'Cookbook' contains the cooking profiles stored in the memory of the appliance. It displays favourites, cooking profile groups and a complete listing of all cooking profiles available.
	Cleaning / Temp change	'Cleaning / Temp change' allows the cavity temperature to be changed and the appliance to be prepared for cleaning with reminders displayed to assist during the cleaning process.
	Settings	'Settings' are used to control the appliance settings and functions including time and language, loading cooking profiles and for service and maintenance purposes.

The easyTouch screen display









The easyTouch® screen display, layout and icons shown herein are for guidance purposes only and are not intended to be an exact representation of those supplied with the appliance.

6.4 The keyboard screen

Appearance



The buttons and their functions

Button	Meaning	Function
	Keyboard screen	The keyboard screen is used to enter an authorised password to enter data for programmes and may restrict operator access to some functions.
	Clear screen	Select the 'clear screen' key to delete text from the keyboard screen.
	Keyboard	Type in text using the keyboard.
	Spacebar	Select the 'spacebar' key to insert a blank.
	Return	Select the 'return' key to start a new line.
	Keyboard scroll	Select the up/down arrows to scroll the keyboard screen.
	Enter / OK	Select the green check mark to confirm settings and continue.
	Previous screen	Select the 'backspace' key to return to a previous screen.

Character length

- For names of cooking profiles, names of cooking profile groups and passwords use 1-20 characters in 2 lines max.
- For stage instructions of individual cooking profiles use 1-54 characters in 5 lines max.

6.5 Using a USB stick

Purpose of the USB cover

The USB cover protects the USB port so that no water vapour can get into the control electronics during cooking or cleaning.

During cooking and cleaning, there must not be a USB stick inserted and the USB port must be closed by the cover.

USB programs

IMPORTANT:

Downloading from a USB memory stick will clear all the existing programs in the memory of the appliance.

Check that the key has the correct number/code for the programs you want to load into the memory (1 'cbr' + 'autoupd.ate').

1.

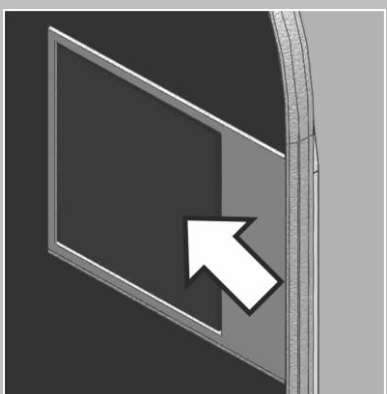

Switch the appliance OFF.
Open the cover to the USB port on the control panel.

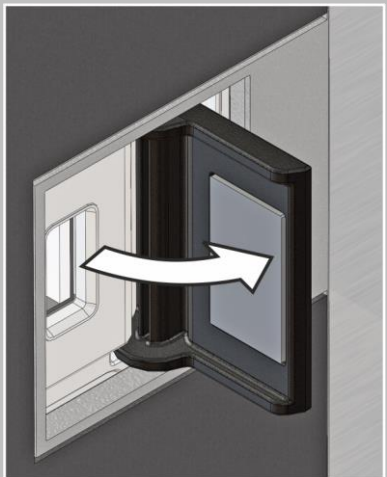

2.

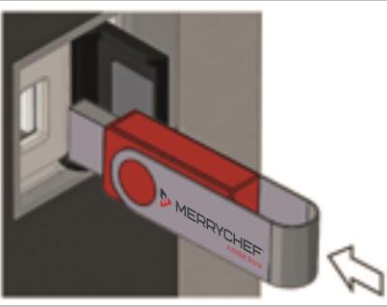

Plug in the USB memory stick.
If the USB memory stick is too large, use a standard commercial adapter cable.



Switch the appliance ON.
The files automatically download from the USB memory stick showing the progress and confirmation screens for the update.



On completion the appliance displays the start up screen.
Then the thermometer symbol is displayed.
Remove the USB memory stick and keep it in a safe place.

7 Cleaning procedures

Purpose of this chapter

This chapter summarizes the cleaning methods, the cleaning chemicals and how to handle them and the cleaning instructions. It explains the correct procedure to follow when cleaning the microwave combination oven.

Contents

This chapter contains the following topics:

	Page
Daily cleaning tasks	63
Cleaning chemicals	64
Items required for cleaning	65
Safe working when cleaning	66
Cleaning procedures	68

7.1 Daily cleaning tasks

What must be cleaned?	Procedure	Cleaning chemicals
Cavity	Clean by hand with a soft cloth / paper towel	Cleaning and protective chemicals approved by the manufacturer
Outside of appliance	Clean by hand with a soft cloth	Common household stainless steel cleaner or hard surface cleaner
Containers, baking sheets, shelf grills and other accessories used for cooking	<ul style="list-style-type: none">▪ Clean by hand with a soft non-abrasive sponge▪ Rinse off after with water	Common household detergent

7.2 Cleaning chemicals

Cleaning chemicals

Use solely the cleaning chemicals specified here to clean the microwave combination oven and its accessories.

Product	Use
Merrychef Cleaner	Cleaning the cavity and appliance door
Merrychef Protector	Protecting the cavity and appliance door
Common household stainless steel cleaner or hard surface cleaner	Caring for the external surfaces of the microwave combination oven
Common household detergent: mild on skin, alkali-free, pH-neutral and odourless	<ul style="list-style-type: none">▪ Cleaning components and fittings according to relevant instructions▪ Cleaning containers, baking sheets, shelf grills and other accessories used for cooking

Handling the cleaning chemicals

You must wear personal protective equipment when using certain cleaning chemicals.

Follow the instructions given in the chapter '*Personal protective equipment*' on page 40 and the current safety datasheets pertaining to cleaning and protective chemicals recommended by the manufacturer.

Personnel must be trained regularly by the person responsible for the microwave combination oven.

7.3 Items required for cleaning

Items required for cleaning

- Merrychef cleaning chemical
- Merrychef protective chemical



- Protective rubber gloves
- Non-abrasive nylon scrub pad
- Cleaning towel and cloths
- Eye protection
- Heat proof gloves (optional)
- Dust mask (optional)



NOTICE

- Never use sharp implements or harsh abrasives on any part of the appliance.
- Do not use tools.
- Do not use caustic cleaners on any part of the appliance or cavity. It will cause permanent damage to the catalytic converters.



7.4 Safe working when cleaning

Your safety and the safety of your staff

Before your personnel start working with the microwave combination oven for the first time, familiarize yourself with the information contained in the chapter '*For your safety*' on page 17 and make relevant safety arrangements.

Instruct your personnel to learn the safe-working rules given in this section before starting work, and to follow them strictly.

Instruct your personnel to familiarize themselves with the hazard warnings listed in this section and in further instructions below, and instil in them the importance of taking the specified precautions.

Personal protective equipment for your personnel

Instruct your personnel to wear the correct personal protective equipment specified in the section '*Personal protective equipment*' on page 40 of the '*For your safety*' on page 17 chapter for the relevant tasks.

Rules for moving and setting up the wheeled trolley safely

To avoid hazards, the following rules must be observed when moving the wheeled trolley that carries the appliances (optional accessory):

- Watch out for all connecting cables when moving appliances. Never wheel over the connecting cables. Never stretch let alone pull off the connecting cables.
- The appliances must be disconnected from the electrical supply before moving the stacking kit (optional accessory).
- The appliances must be left to cool down on the trolley before being moved.
- There must not be any food left in the appliances.
- The appliance door must be closed.
- Protective clothing must be worn if the appliance is mounted on a trolley.
- It is important to ensure that the unit is level once is back in place.
- Once the unit is back in place, the parking brakes must be engaged again.
- Whatever the position, care must be taken to ensure that the trolley carrying the appliance does not tip over.

Spraying down the appliance with water

⚠ DANGER

Risk of electric shock from live parts

Water on the exterior of the appliance can cause a short-circuit, which may result in electric shock on touching the appliance.

- ▷ Do not spray the interior and exterior of the appliance with water.
- ▷ Always keep the USB cover closed during cleaning.

Hot surfaces

⚠ WARNING

Risk of burns from high temperatures on interior parts of the appliance

You may get burnt if you touch any of the interior parts of the cavity, the inside of the appliance door or any parts that are or were inside the oven during cooking.

- ▷ Before starting cleaning tasks, wait until the cavity has cooled to below 50°C / 122°F or use the Cool Down function to cool the cavity.
- ▷ Wear personal protective equipment.

Spraying water into a hot cavity

⚠ WARNING

Risk of scalding from hot steam

If water is sprayed into the hot cavity, steam will be produced that may scald.

- ▷ Before starting cleaning tasks, wait until the cavity has cooled to below 50°C / 122°F or use the 'Cool Down' function to cool the cavity.

Contact with cleaning chemicals

⚠ WARNING

Risk of irritation to skin, eyes and respiratory system.

Direct contact with the cleaning or protective chemicals will irritate the skin, eyes and respiratory system.

- ▷ Do not inhale the vapours or spray mist from the cleaning and protective chemicals.
- ▷ Do not let the cleaning or protective chemicals come into contact with skin, eyes or mucous membranes.
- ▷ Do not spray cleaning or protective chemicals into a cavity.
- ▷ Wear personal protective equipment.

7.5 Cleaning procedures

Cleaning the microwave combination oven

This section explains how to clean your microwave combination oven.

Contents

This section contains the following topics:

	Page
Cool down procedure before cleaning	69
Cleaning instructions	72

7.5.1 Cool down procedure before cleaning

For your safety when cleaning

Before starting cleaning work, it is essential that you familiarize yourself with the rules and hazard warnings specified in 'Safe working when cleaning' on page 66, and follow the instructions given there.

Purpose

With the optional 'cool down' function you can cool down the cavity quickly for cleaning your microwave combination oven sooner.

Cooling down the cavity

1.  In 'Full Serve mode', select the 'cleaning' symbol from the main menu.

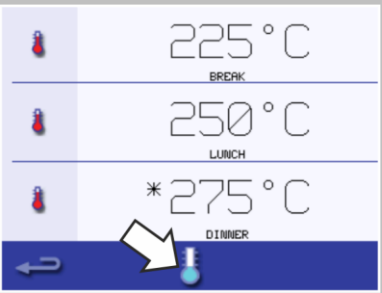
2.  In 'Full' or 'Quick Serve mode', select the 'blue thermometer' symbol to disable heating and to start the cooling cycle. A prompt appears.

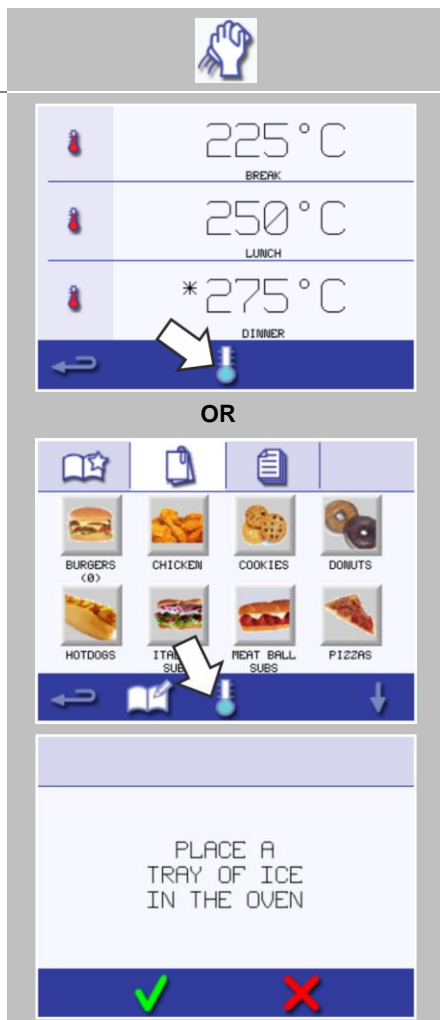

3.



Taking all necessary precautions place a suitable tray of ice cubes or cold water into the hot cavity. This speeds up the cooling process.

Once the tray of ice is in the oven, press the green tick to continue.

4.

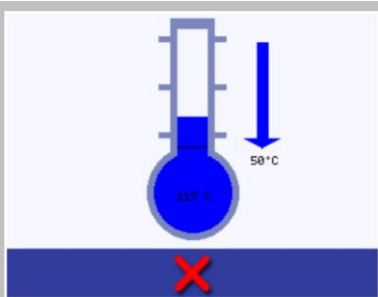

The cooling progress is displayed and takes approximately 20 minutes.

To reduce the cool down time, leave the appliance door open slightly during the cooling process.

5.



Once the cooling process is complete, carefully remove the cool down pan from the cavity wearing protective gloves. The pan of water should not be left in the oven overnight or when cold.

6.



The oven is now ready for cleaning.

7.5.2 Cleaning instructions

▲ For your safety when cleaning

Before starting cleaning work, it is essential that you familiarize yourself with the rules and hazard warnings specified in 'Safe working when cleaning' on page 66, and follow the instructions listed.

Requirements for cleaning the appliance

- The appliance has been cooled down correctly.
- No food has been left in the cavity.
- All containers, baking sheets, shelf grills and any other accessories have been removed from the cavity.

Cleaning process

Cleaning oven and oven parts

1.



Open the appliance door and remove the cook plate / wire rack and any other cooking accessories from the cavity.

NOTE: You can at this stage also remove the air filter to wash it with the other parts (see steps 12-13 for instructions on how to remove the air filter) or you can remove and clean the air filter later (steps 12-17).

CAUTION: Wear protective glasses and protective rubber gloves during the cleaning procedure.

2.

Wash all removed oven parts in warm soapy water. Wash off using a clean cloth and plenty of clean, warm water. Dry all components using a fresh, clean cloth.

3.

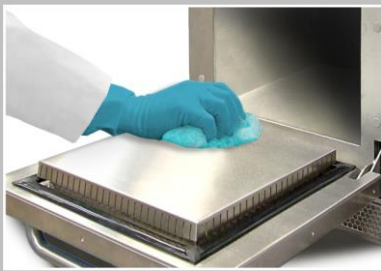

Remove any spillages with suitable cloth or paper towel. Use a dry clean brush to remove any food particles from between the cavity floor and the inside of the front door.

4.



Carefully spray cleaning chemical approved by Merrychef onto a sponge.

Clean all surfaces of the cavity **except the roof (jet plate) and door seal.**

NOTICE:

Do not spray directly into the cavity.

Do not clean the roof of the cavity.

Do not use cleaning chemicals or oven protector on the cook plate.

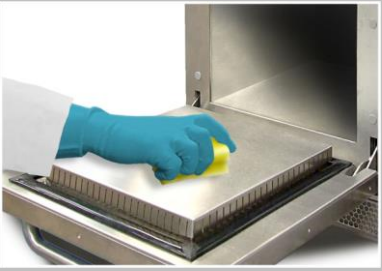
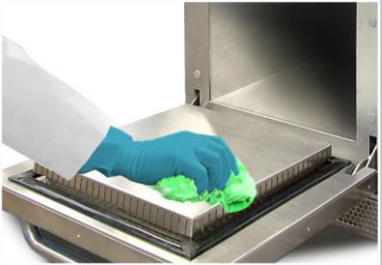
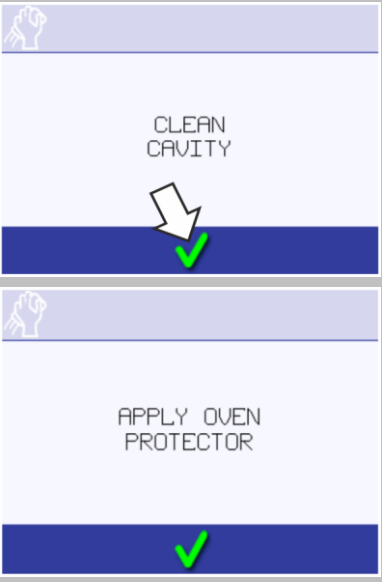
<p>5.</p>		<p>For difficult areas, leave to soak for 10 minutes with the appliance door open.</p> <p>Use a non-abrasive nylon scrub pad/sponge to clean all surfaces of the cavity and the inside surface of the appliance door.</p> <p>NOTICE: Do not scrub the roof (jet plate) or door seal or use metallic scourers.</p>
<p>6.</p>		<p>Wash off all surfaces using a wet, clean cloth.</p> <p>Dry using a fresh, clean cloth or paper towel.</p> <p>If required the cavity roof and door seal can be wiped clean with a wet clean cloth as well.</p>
<p>7.</p>		<p>Press the green tick to confirm the cavity has been cleaned.</p> <p>You will be prompted to apply protective chemical (oven protector).</p> <p>NOTE: The application of protective chemical is optional but recommended to make cleaning easier the next day.</p> <p>Follow steps 8-11 below to apply oven protector</p> <p style="text-align: center;">or</p> <p>Press the second green tick to skip applying the protective chemical, replace the cook plate and any other parts removed for cleaning and go to step 12 to complete the remaining cleaning procedures.</p>

Applying the protective chemical (optional)

<p>8.</p>		<p>Spray protective chemical approved by Merrychef onto a clean sponge.</p> <p>NOTICE: Only apply the protective chemical to a clean appliance. Ensure protector is only wiped on cavity metal surfaces Ensure the oven is heated before putting cook plate in.</p>
-----------	---	--

9.

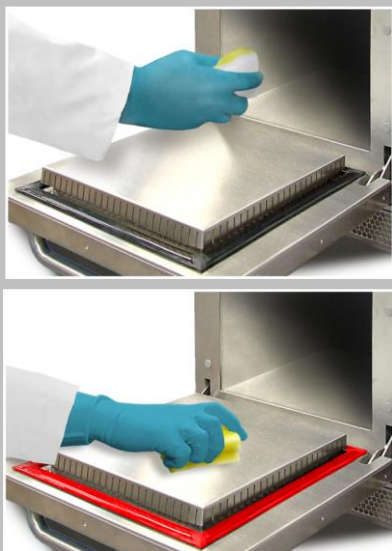

Spread the protective chemical lightly onto all internal surfaces of the appliance **avoiding the roof (jet plate) and door seal (marked in red).**

10.



Close the appliance door.

11.

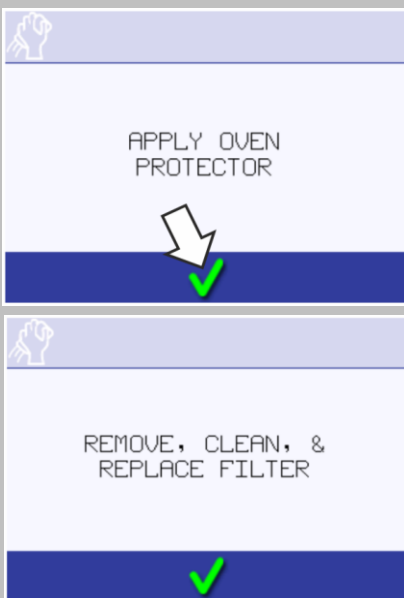

Press the green tick to confirm application of the protective chemical.

When the green tick is pressed, a prompt appears asking to clean the air filter.

Cleaning the air filter

12.



With the oven door closed, tilt the faceplate below the door downwards.

13.



Remove the air filter by gently pulling it out.

14.

Clean the air filter with a damp cloth or wash it in soapy water and dry it thoroughly.

15.

Replace the air filter and tilt the faceplate in its original position.

16.

Clean the oven exterior with a damp cloth.

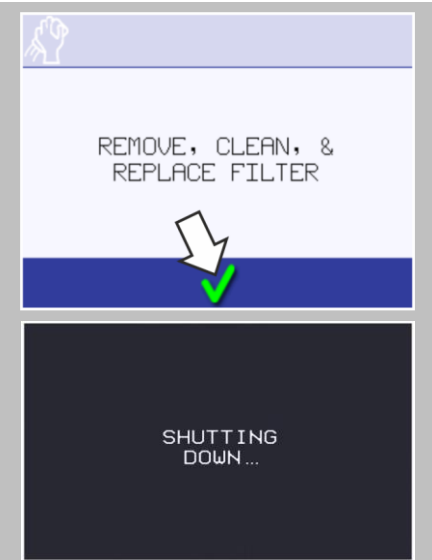

17.



Press the green tick to confirm cleaning of the air filter.
The oven switches OFF.

The oven is now ready to be used again if you did not apply protective chemical. If protective chemical was applied, it must be cured, go to step 18.

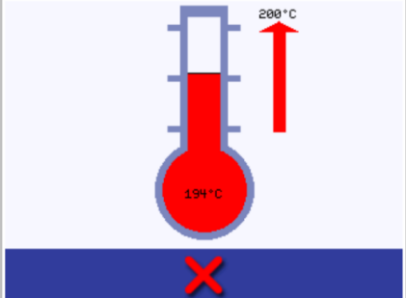
Curing protective chemical

18.		<p>Switch ON the appliance.</p> <p>NOTE: If the air filter has not been replaced the screen will display a warning. Replace the air filter and then press the green tick to continue.</p>
19.		<p>Preheat the cavity.</p> <p>Once reaching the preset operating temperature it will take about 30 minutes to cure the protective chemical, if it was applied.</p> <p>The protective chemical turns light brown when cured.</p>
20.		<p>Replace the cleaned and dried cook plate and any other parts removed for cleaning.</p> <p>Ensure the cook plate / wire rack is fitted on to the cavity support stubs.</p> <p>The oven is now ready again for cooking.</p>

8 Technical data

Purpose of this chapter

This chapter contains the technical data for your microwave combination oven.

Contents

This chapter contains the following topics:

	Page
Technical data	78
Dimensional drawings	80

8.1 Technical data

Dimensions and weights

Width				
Including packaging	[in]	21.1	[mm]	535
Appliance without packaging	[in]	14.0	[mm]	356
Height				
Including packaging	[in]	33.5	[mm]	850
Appliance ("Classic" exterior) without packaging	[in]	24.4	[mm]	620
Appliance ("Trend" exterior) without packaging	[in]	25.4	[mm]	644
Depth				
Including packaging	[in]	35.3	[mm]	895
Appliance without packaging, door closed	[in]	25.0	[mm]	636
Weight				
High Power version, including packaging	[lbs]	155	[kg]	70.4
High Power version, excluding packaging	[lbs]	134	[kg]	61.0
Standard Power version, including packaging	[lbs]	135	[kg]	61.1
Standard Power version, excluding packaging	[lbs]	114	[kg]	51.7
Safety clearances				
Rear / right / left	[in]	0	[mm]	0
Top (for ventilation)	[in]	2	[mm]	50

Electrical connected load ratings - High Power version

Electrical supply	1N~ 220-230V 50Hz	2N~ 380-400V 50Hz	1N~ 220V 60Hz	2~ 200V 50/60Hz
Connections used	L + N + E	L1 + L2 + N + E	L + N + E	2P + GND
Arrangement	Single Phase	Twin Phase	Single Phase	Two Pole
Rated power consumption [W]	6000	2500 + 3300	6000	6000
Rated current per phase [A]	32	16 / 32	32	32
Power output				
Rated power output convected heat [W]	2200	2200	2200	2000
Rated power output microwave (IEC 705) 100% [W]	2000	2000	2000	2000
Rated power output combination mode [W]	2200 + 2000	2200 + 2000	2200 + 2000	2000 + 2000

Electrical connected load ratings - Standard Power version

Electrical supply	1N~ 220-230V 50Hz	1N~ 220-230V 50Hz	1N~ 220V 60Hz
Connections used	L + N + E	L + N + E	L + N + E
Arrangement	Single Phase	Single Phase	Single Phase
Rated power consumption [W]	2990	3680	2860

8 Technical data

Rated current per phase	[A]	13	16	13
Power output				
Rated power output convected heat	[W]	2200	2200	2200
Rated power output microwave (IEC 705) 100%	[W]	1000	1000	1000
Rated power output combination mode (convected heat + microwave)	[W]	900 + 1000	1300 + 1000	900 + 1000

Regulatory standards compliance

Degree of protection	IPX0
Noise emission	max. 70 [dBA]
Approval marks	
Tested safety	CE, CB (IEC)
Hygiene	UL-EPH (NSF/ANSI 4)

8.2 Dimensional drawings

eikon e2s

Front view (door closed)

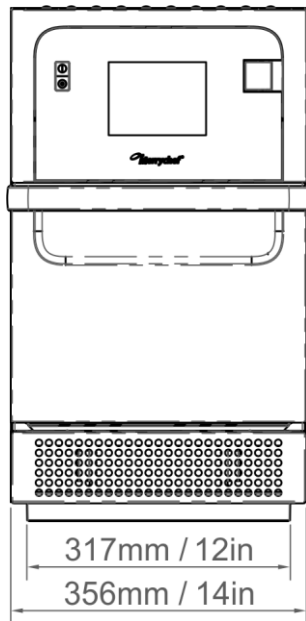

Cavity dimensions (door closed)

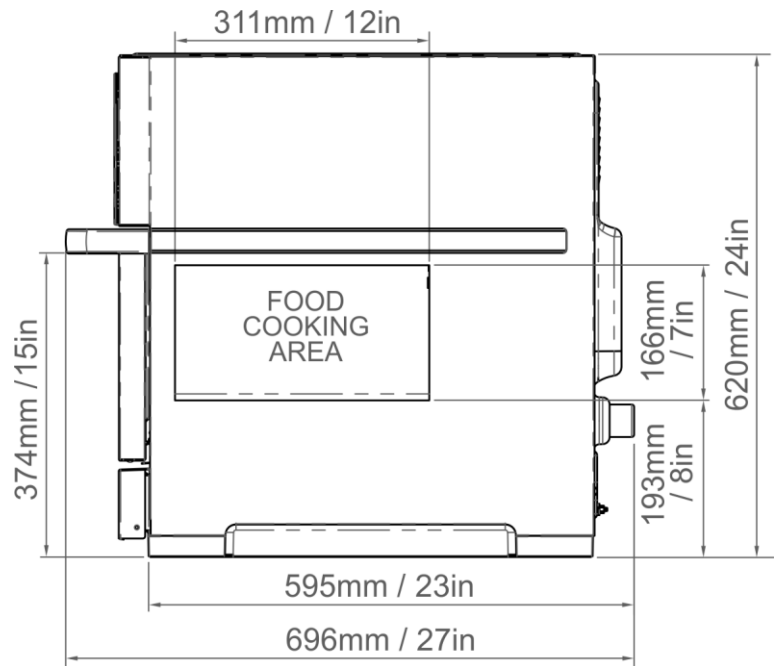

View from the top (door closed)

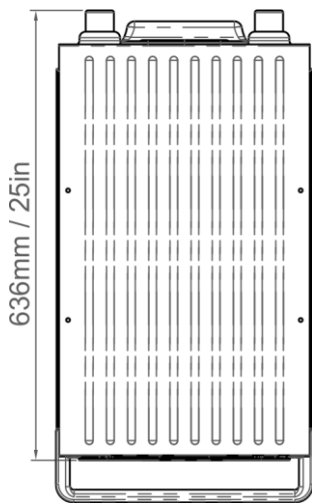

View from the right hand side (door open)

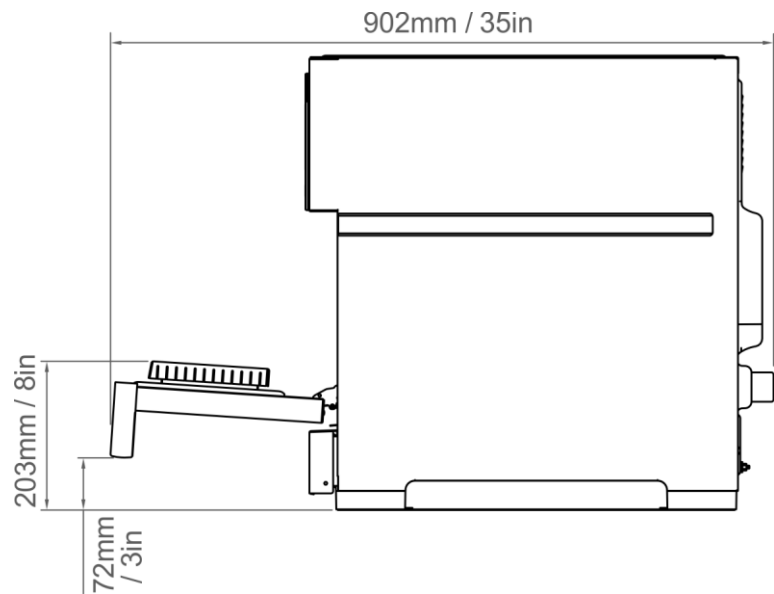

9 Diagnostics

Purpose of this chapter

This chapter contains information on checking various functions of your microwave combination.

Contents

This chapter contains the following topics:



	Page
Checking the condition of your appliance	82
Errors and diagnostics	86
Fault finding	93

9.1 Checking the condition of your appliance

Servicing procedure: overview

1. Disconnect/isolate the appliance from the power supply.
2. Check the appliance is correctly installed as described in the "Installation" section of this manual.
3. Visually check the cleanliness/condition of the power supply/cable/gland, casing, cavity and door of the appliance for signs of wear, damage, distortion etc. If required, refer to the "Replacing components" section of this manual.
4. Complete an "Earth/Insulation test" (see "Tests" section of this manual) on the appliance before switching on.
5. Check the display for error messages. If an error is shown, refer to the "Diagnostics" section of this manual.
6. If a firmware update is required, follow the instructions under "Firmware Updates" before continuing with the service procedure.

Enter Service Mode

- | | | |
|----|---|--|
| 1. |  | On start up, tap the top right of the splash screen to bypass preheat of the cavity. |
| 2. |  | Enter the authorised user password, for example, "MANAGER" on the keypad.
Select OK to display the 'Settings' menu. |
| 3. |  | Select the spanner symbol. |

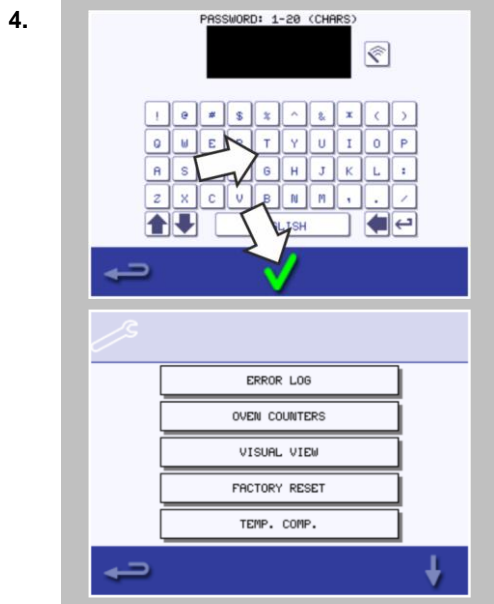

Enter the service password, for example, "SERVICE" on the keypad.
 Select OK to display the Error Log, service information and test options.

Touchscreen Calibration



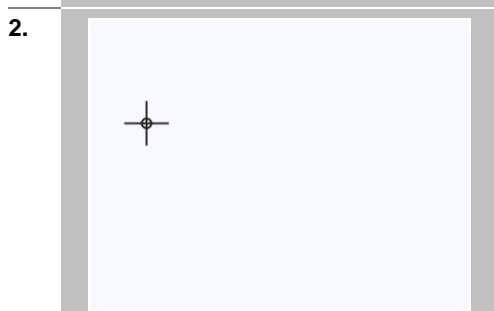

Apply continuous light pressure to the screen while switching the appliance on.
 Continue to hold until the progress bar has completed.

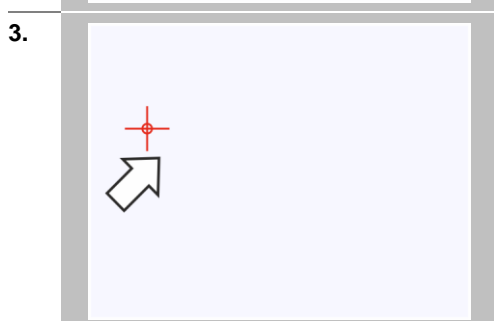

Using a non-abrasive pointer, such as a ball point pen, accurately press the centre of each crosshair displayed on the screen.

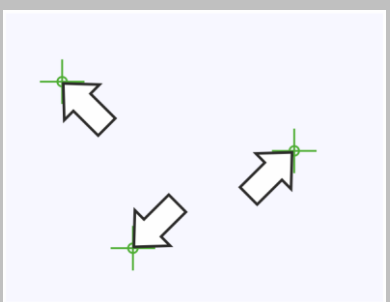

If the crosshair turns red you missed the centre of the crosshair.
 Repeat the procedure.

- | | | |
|----|---|--|
| 4. |  | <p>If the crosshairs turn green three times consecutively the calibration process is completed successfully.</p> |
| 5. |  | <p>Once calibrated the screen will display information about the appliance.</p> |

Functions of the Service Mode

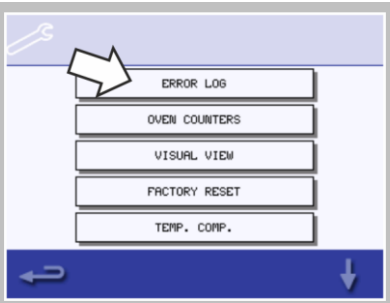
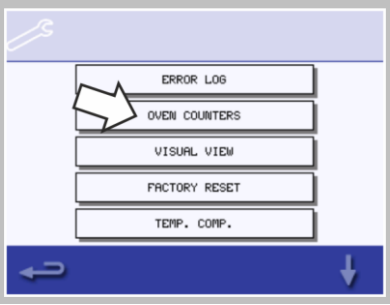
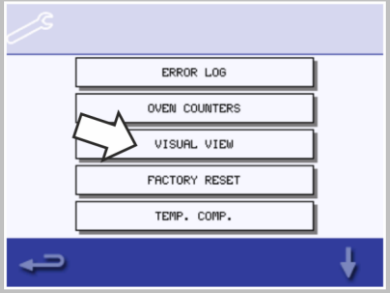
- | | | |
|----|---|--|
| 1. |  | <p>Check the "Error Log" for details of any logged appliance errors.</p> |
| 2. |  | <p>Check the "Oven Counters" to find the usage of components and the controls area temperature within the cabinet.</p> |
| 3. |  | <p>Check the operational performance of the main components using "Visual View".</p> |

4.

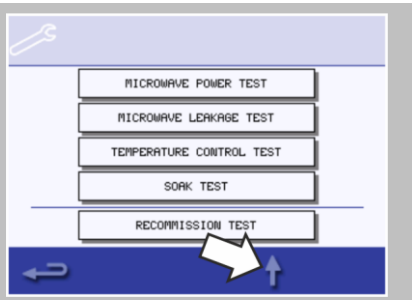

Perform the tests of your microwave combination oven as described.
See "Tests" section of this manual.
If required refer to the "Replacing components" section for any repairs needed before continuing with the tests.

5.

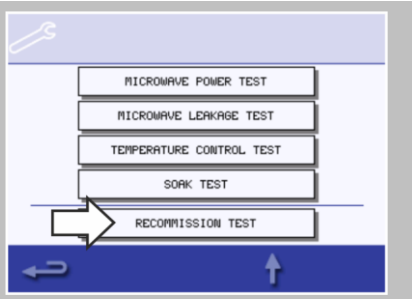

Follow the procedures under "Commissioning the appliance" before commissioning your appliance for use.

9.2 Errors and diagnostics

Error messages

1.



A description of the type of error is shown.

Check for a number following 'ERROR:' and refer to the error codes ("Fault Finding" section of this manual) for more details.

The serial number of the oven, model, UI (QTS) version and SRB version information are also displayed below.

2.

Clear the error message by power cycling the mains power supply to the oven (not the oven ON/OFF switch).

Copying error messages

1.



Enter settings menu and select the USB symbol. The USB screen appears.

2.

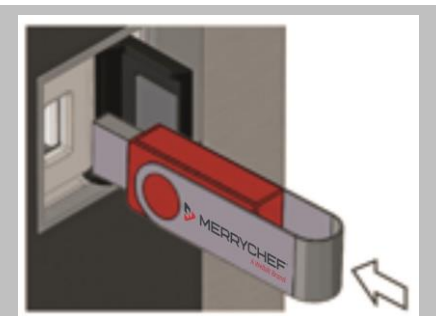

Open the cover of the USB port and insert the USB memory stick into the slot.

NOTE:

The USB memory stick may take several seconds to load before the screen will respond.

3.

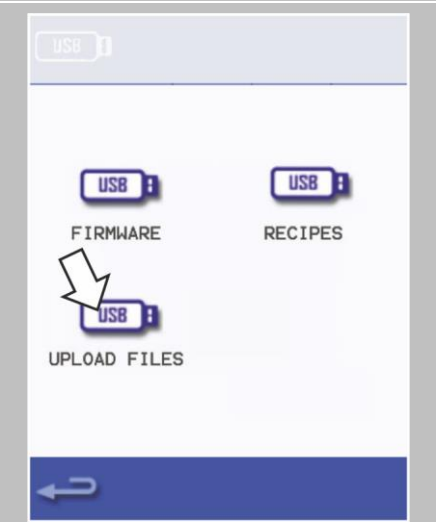



Select 'Upload Files' on the USB screen.

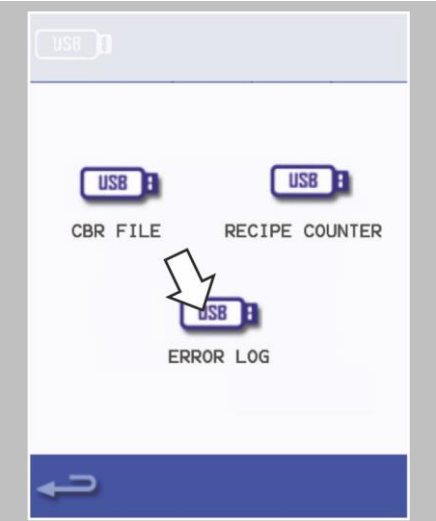

4.

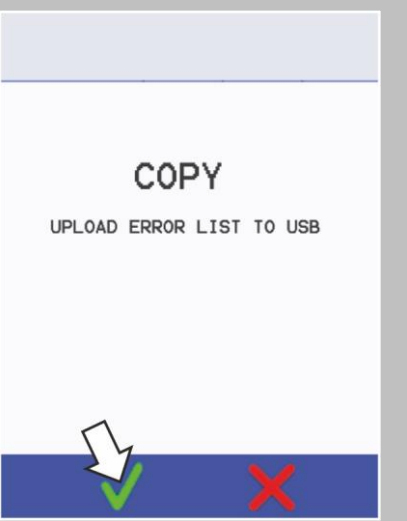

Select 'Error Log' on the following screen.

5.  Select the green check mark to copy the error log to the USB memory stick.
The upload progress is shown followed by the upload status.
6.  Select backspace 3 times to return to the main menu.
7.  Remove the USB memory stick.

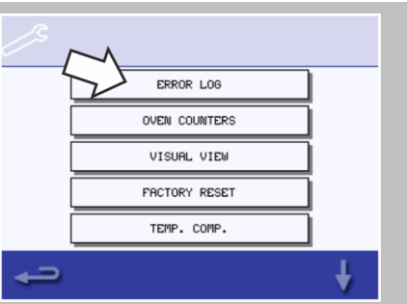
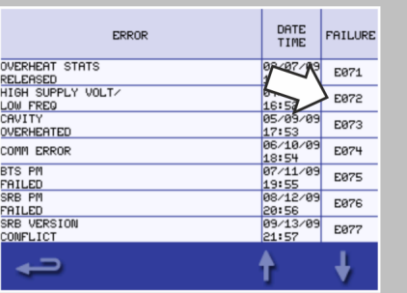
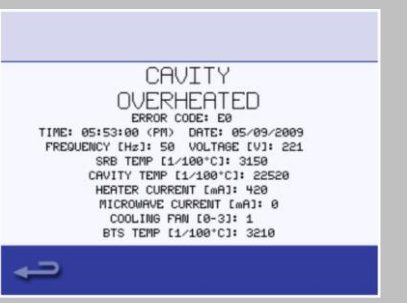
Error Log

1.  Enter Service Mode and select 'Error Log' to display a listing of oven component errors.
2.  Scroll down the list (if necessary) and select an error from the list to display individual records.
3.  Error details include: component description, error caused, date and time of the error with details of failure and range.
4.  Select backspace to return to the list, again to return to the Service Menu.

Cooking Profile counter

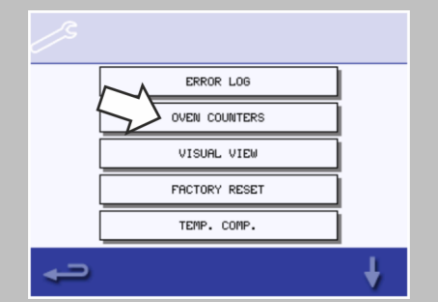
1. 

Select 'Oven Counters' to display the oven component usage and ambient controls area temperature.

2. 

Details include the number of screen touches, filter cycles, door cycles, total oven power, magnetron and heater element power on time and the ambient controls area temperature in the cabinet.

3. 

Select backspace to return to the Service Menu.

Visual View

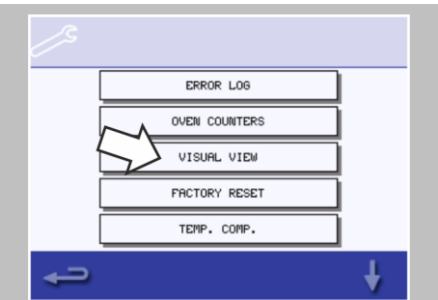
1. 

Select 'Visual View' to check the main components of the appliance.

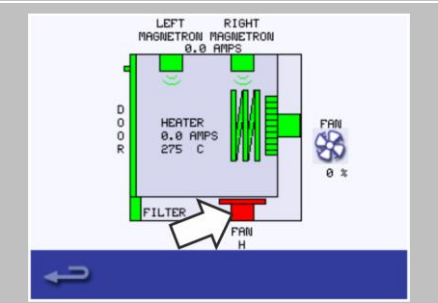
2. 

Select a component symbol to switch on (red).
Select again to increase the level or turn off (green).

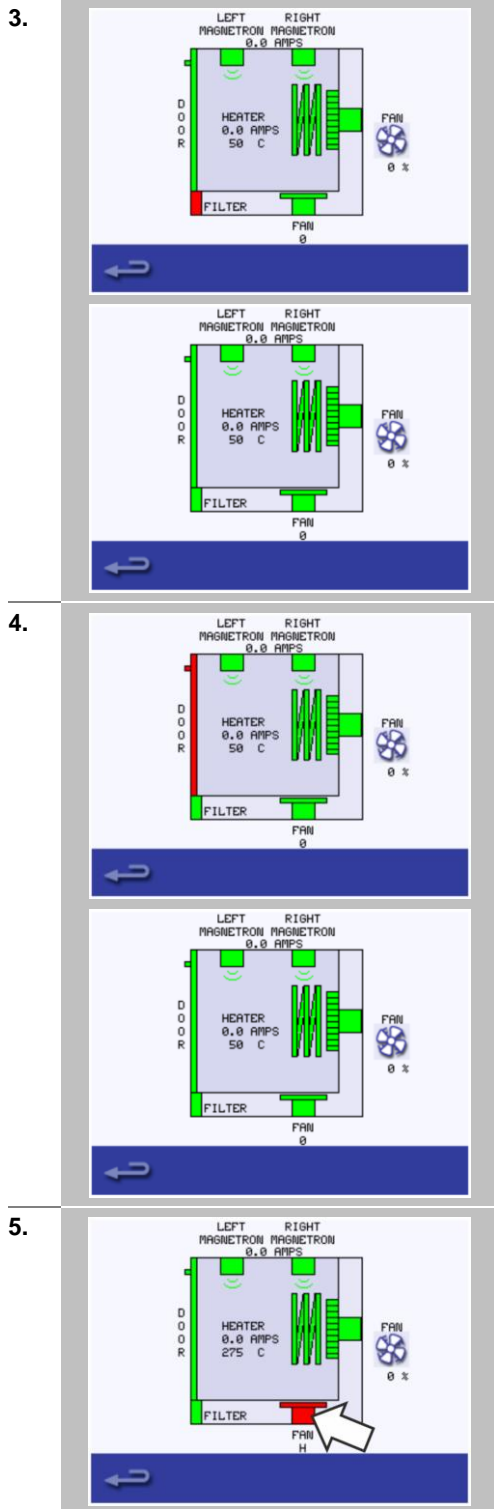

Remove the air filter at the front of the oven.
 The colour of the air filter symbol on the display should change from green to red indicating that the magnetic reed switch circuit for the air filter is operating correctly.
 Replace the air filter and the colour should change back to green.

Open the oven door.
 Check the colour of the door symbol changes from green to red on the display to check the door microswitch / interlock circuit is operating.
 Place door spacers onto the oven door (refer to "Adjusting the door microswitches / interlocks" in the "Replacing components" section for details), close the door and check the colour of the door symbol on the display.
 Green colour indicates that the door interlock adjustment is ok.
 Red colour indicates that the door interlock adjustment procedure must be completed.

Select the cooling fan and check if it is operating correctly.
 When increasing the fan power from L (low) to H (high) the fan noise should become louder.

6.



Place a microwave safe container of water into the cavity, and close the oven door.
 Select a magnetron to test the current draw at maximum output, this will time-out after 30 seconds.
 Dual magnetron model (2000W e2s variant):
 Test the magnetrons individually and together.
 Using heat proof gloves, remove the container and close the oven door.
 Individual magnetron test:
 If there is a magnetron error present, then first reset the error.
 If during the magnetron test the current is between 1.1 - 2.2 A and the error re-occurs after 8 seconds then the failure can be found in the 230V circuit.
 Refer to the schematics to find the fault for repair (fuses, SRB, door switches, connections, power supply).
 If during the magnetron test 0 A and the error reoccurs after 8 seconds then the failure can be found in the high voltage circuit.
 Replace high voltage components (diode/rectifier, capacitor or magnetron) to find out the failing component. Never measure in the high voltage circuit. See "Replacing components" section of this manual.

7.

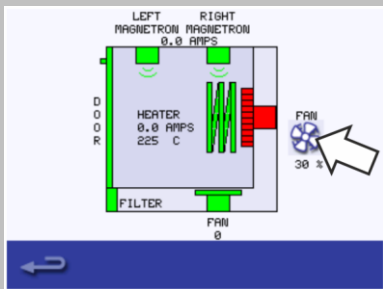

Select the convection fan and check if it is operating correctly.
 When increasing the fan power gradually to 100% the fan noise should become louder.

8.

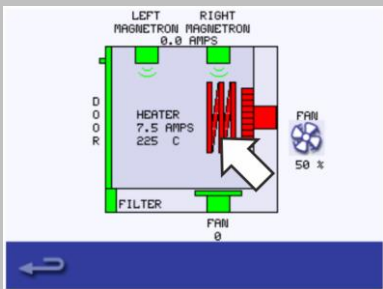

Select the heater, it increases to maximum temperature and then cycles (the convection fan is ON by default).
 Check the cavity temperature and heater element current draw at maximum are correct. The current should be between 7 A and 9 A depending on domestic mains voltage.

9.

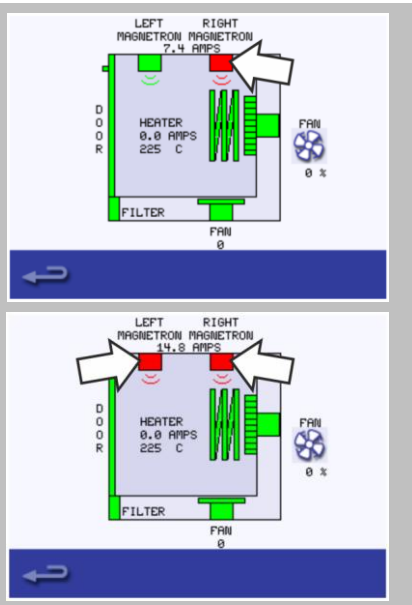

Select one and then the second magnetron (2000W e2s variant only) and check if they are operating correctly.

9.3 Fault finding

Hardware control components

Operations communication:

1. The oven has two main parts being the QTS assembly (keyboard, screen, logic) and the SRB (Smart Relay Board to switch and monitor the required operation).
 2. The QTS is the master of the oven and instructs the SRB what to do, in turn the SRB communicates information on the operation back to the QTS.
 3. The QTS and SRB have their own Personality Module (PM) fitted with the respective software to be able to communicate and work with each other.
 4. The power provision to the QTS and the communication between QTS and SRB is enabled via ONE cable with RJ45 connectors fitted.
-

Start up sequence

With the oven switch in the OFF position and the mains power ON, the QTS & SRB boards boot up. When the oven switch is turned ON the splash screen briefly displays oven information and the cabinet cooling fan is activated.

After completing a successful logic test, the safety relay is energised and the oven preheats or displays a preheat temperature choice. Once preheated the oven displays the main menu if in "Full Service Mode" or a recipe selection if in "Quick Service Mode".

Shutting down sequence

When the oven switch is turned OFF the screen displays 'Shutting Down' and the cooling fan operates until the cabinet temperature has been sufficiently reduced (cavity temperature of 50°C / 122°F).

The safety relay is de-energised and the QTS & SRB boards remain active.

Exchanging data via USB interface

Procedures of exchanging data by using the USB memory stick:

- Menu loading from the USB memory stick to the appliance (recipes / download)
- Software loading from the USB memory stick to the appliance (firmware / download)
- Error log saving from the appliance to the USB memory stick (upload)
- Menu copying from the appliance to the USB memory stick (upload)
- Recipe counter copying from the appliance to the USB memory stick (upload)

Error code list

Error Code	Error Condition	Description	Trigger	Possible Causes	System Response
E 101	Magnetron failed to energise	Detects a magnetron is not working correctly	The current measured by the current sensing transformer was outside of tolerance.	Failure of component/s in the microwave circuit	Display error message until system is power cycled.
E 102	Heater incorrect current	Detects a heating element is not working correctly	The current measured by the sensing transformer on the SRB was <1A when heating cycled on or >1A when heating cycled off.	If some current >1A, one or more heater elements could have failed. If current measured <1A possible wiring fault stopping power reaching element.	Display error message until system is power cycled.
E 103	Ambient overheat >70°C	Detects if the controls area is operating above temperature	The ambient temperature measured on the QTS and SRB was >70°C	Cooling fan failed. Cooling fan wired incorrectly. Inlet air too hot. Blocked inlet filter.	Display error message until ambient controls area temperature is below 60°C.
E 104	Magnetron / cavity overheat	Detects if the cavity and magnetrons are above temperature	Cavity and magnetron overheat thermostats	Cooling fan failed. E103 / E106 not triggering. Failed SRB. Magnetron failure. Wiring / connection fault. Blocked inlet filter.	Display error message until service call and the magnetron cools down or the cavity stat is reset.
E 105	Supply frequency high / low	Detects if the power supply frequency is outside specification	The power supply to the oven frequency sensor on the SRB measures too high / low	Incorrect mains voltage. Poor internal / external wiring connections. Faulty SRB.	Display error message until system power cycled.
E 106	Cavity reaches 25°C above setpoint once it has been controlling at setpoint	Detects if the cavity temperature has risen above limits	The setpoint of the appliance was exceeded	Cavity fire. Failed convection fan. No impeller or loose impeller on convection fan.	Display error message until system is power cycled.
E 107	Communication error	No communication can be made between the QTS and SRB	Loss of communication between the SRB and QTS	SRB / QTS connection cable unplugged or damaged. Faulty QTS or SRB.	Display error message until system is power cycled.

Error Code	Error Condition	Description	Trigger	Possible Causes	System Response
E 108	QTS PM error	Wrong PM found / no PM found	The QTS or SRB either has an incorrect PM (Personality Module) fitted or no PM is fitted	The PM has been changed and is incorrect. The PM has been removed.	Display error message until system is power cycled.
E 109	SRB PM error				
E 110	SRB version conflict	SRB firmware version incompatible with QTS version	The QTS has found that the firmware running the SRB is not supported.	Firmware update has been carried out to the QTS and the SRB has not been updated to match.	Display error message until system is power cycled.
E 111	Cavity sensor error	Cavity sensor broken / unplugged	The controller is reading an open circuit across the thermocouple input	The thermocouple is not connected. The thermocouple is broken open circuit. Failed SRB.	Display error message until system is power cycled.
E 112	SRB sensor fail	SRB ambient temperature sensor failure	Shorted SRB temperature sensor	Shorted Ambient temp sensor on the SRB	Display error message until service call and the magnetron cools down or the cavity stat
E 113	Magnetron fail on without request	Magnetron operates without being requested to do so.	Magnetron current sensed at >1 Amp	Triac, Diode or relay short circuited on SRB	Display error message until service call and the magnetron cools down or the cavity stat is reset.
E 116	Heater off on request	No heater current detected when requested	Cavity does not reach 100°C in 30 minutes	Oven heater element failure	Display error message until service call and the magnetron cools down or the cavity thermostat is reset.
E 117	Magnetron overheat thermostat	Magnetron overheat thermostat has been triggered as a result of excessive temperature	Magnetron stat is open circuit when running microwave	Blocked air filters / high environmental temperatures / Positioning next to heat sources or failed magnetron	Display error message until service call and the magnetron cools down or the cavity thermostat is reset.
n/a	Oven door open longer than 1 min.	Oven door open. Oven inoperable.	Break in switched feed on SRB	Door left open. Failed door switch/s or SRB. Faulty wiring or connection.	Display warning message until door is closed.

Error Code	Error Condition	Description	Trigger	Possible Causes	System Response
n/a	Air filter removed	Air filter not fitted. Oven inoperable.	Filter not fitted.	Failed reed switch/s or SRB. Faulty wiring or connection.	Display error message until filter replaced.
n/a	Screen frozen	Touch screen inoperable	Continual pressure of the touch screen	Damaged touch screen / touch screen depress for more than 15 seconds.	Display error message until touch screen press released

Error code for recommission test messages

- 89 Cooling test fail
- 90 Convection test fail
- 92 Heater test fail
- 93 Magnetron test fail
- 94 Air filter in test fail
- 95 Air filter out test fail
- 96 Door closed test fail
- 97 Door open test fail
- 98 Incomplete cleaning

Normal error messages

- 86 On/Off switch operated
 - 99 Air filter override accepted by the customer
 - 100 Main power On, oven connected to the supply door open (for more than 1 minute)
- If 'Door Open' message is shown while the door is closed, check the Magnetron 230V circuit power supply.

Error messages (the oven stops operating)

- 88 Supply voltage error (+/- 10% of rated voltage)
- 101 Magnetron failed on request
- 102 Heater ON without request
- 103 Ambient overheat
- 104 Magnetron/cavity overheat trip, when oven in idle mode (also see E117)
- 105 Supply frequency error (+/- 2Hz)
- 106 Cavity reaches 75°C above set point or 25°C at 275°C
- 107 Communication error QTS-SRB
- 108 QTS Personality Module error
- 109 SRB Personality Module error
- 110 Incompatible SRB version
- 111 Cavity sensor failed
- 112 SRB board sensor failed
- 113 Magnetron on without request
- 114 Free – currently not used
- 115 Convection fan feedback (motor speed controller cable disconnected)

116 Heater OFF on request

117 Magnetron/cavity trip during cook operation cycle (OH-12V gone for > 1sec)

If this OH trip happens in idle mode you get E104.

To reset the error, disconnect the oven from the power supply and re-connect.

10 Tests

Purpose of this chapter

This chapter contains information on testing single components of your microwave combination oven.

Contents

This chapter contains the following topics:

	Page
Safe working when testing components	99
Requirements	101
Testing selected components (casing mounted)	102
High voltage components (casing removed)	110
Mains voltage components (casing removed)	114

10.1 Safe working when testing components

For your safety when testing oven components

Before starting oven tests, it is essential that you familiarize yourself with the rules and hazard warnings specified and follow the instructions given there.

Eligibility of personnel for testing oven components

Only qualified personnel from an authorized service company are permitted to test components of the microwave combination oven.

Live components

DANGER

Risk of electric shock from live parts

When the appliance is not connected to an equipotential bonding system, there is a risk of electric shock from touching live parts.

- ▷ Make sure that any work on the electrical system is performed solely by a qualified electrician from an authorized service company.
- ▷ Make sure that the electrical connections are intact and connected securely before putting the appliance into use.
- ▷ Before preparing the appliance for use, make sure that the appliance, including all metallic accessories, is connected to an equipotential bonding system.

Moving heavy loads

WARNING

Risk of injury from lifting incorrectly

When lifting the appliance, the weight of the appliance may lead to injuries, especially in the area of the torso.

- ▷ Use a forklift truck or pallet truck to place the appliance in the installation position or to move it to a new position.
- ▷ When shifting the appliance into the correct position, use enough people for the weight of the appliance when lifting it (value depending on age and gender). Observe the local occupational safety regulations.
- ▷ Wear personal protective equipment.

Sharp-edged sheet-metal parts

WARNING

Risk of cuts from sharp-edged sheet-metal parts

Working with or behind sharp-edged sheet-metal parts may result in cuts to hands.

- ▷ Exercise caution.
- ▷ Wear personal protective equipment.

Hot surfaces

WARNING

Risk of burns from high temperatures inside the cavity and on the inside of the appliance door

- ▷ You may get burnt if you touch any of the interior parts of the cooking chamber, the inside of the appliance door or any parts that were inside the oven during cooking.
- ▷ Before starting servicing and repair work, wait until the cooking chamber has cooled to below 50°C / 122°F or use the 'Cool-Down' function to cool the cooking chamber.
- ▷ Wear personal protective equipment.

Live components

⚠DANGER

Risk of electric shock from live parts

When the covers of the microwave combination oven are removed, there is a risk of electric shock from touching live parts.

- ▷ Make sure that any work on the electrical system is performed solely by a qualified electrician from an authorized customer service office.
- ▷ Before removing the covers:
 - Switch the appliance off and disconnect the plug from the wall socket.
 - Turn off the isolator switch to disconnect fixed wired appliances and lock-off.
 - Take protective measures at every power switch to ensure that the power cannot be switched on again.
 - Always discharge the high voltage capacitors before working on the appliance using a suitably insulated 10MΩ resistor.
 - Make sure that the appliance is de-energized.
- ▷ Make sure that the electrical connections are intact and connected securely before you reconnect the appliance to the power supply.
- ▷ Before putting the appliance back into operation, make sure that the appliance, including all metallic accessories, is connected to an equipotential bonding system.

Microwave emissions

⚠WARNING

Risk of burns from microwave emissions

- ▷ Do not become exposed to emissions from the microwave generator or parts conducting microwave energy.
- ▷ Never operate an appliance that has failed the "Microwave Leakage test".

Fire / smoke in the appliance

⚠WARNING

Risk of fire and/or smoke

Flames and/or smoke may come out of the oven when switching it on after service/repair. This can be caused by a defective electrical component or electrical connections (wiring) that have been refitted incorrectly.

- ▷ Switch off the oven.
- ▷ Disconnect/isolate the oven from the electrical supply.
- ▷ Keep the oven door closed to stifle any flames.

10.2 Requirements

Equipment required for testing the appliance

- Portable Appliance Tester (P.A.T.)
- Digital Multi-Meter (D.M.M.)
- Megger / similar 500 V d. c. resistance meter
- Microwave detection / leakage meter
- Temperature reader
- Continuity meter
- Door Spacer Kit
- Microwave safe 600 ml glass beaker
- Microwave safe 2 litre container

10.3 Testing selected components (casing mounted)

Technical Advisory Notice: PAT testing of Merrychef ovens

While testing with a Portable Appliance Tester (PAT) is not an automatic requirement for the Merrychef Commercial Combination Microwave oven models, the following notice is to advise on this testing in addition to the following instructions as deemed necessary.

If the customer requires PAT testing of our equipment we suggest this is limited to a) earth continuity and b) insulation resistance (measured at ~ 500 V DC). All Merrychef Commercial Combination Microwave Ovens are classified as CLASS 1 for the purpose of testing.

Should it still be deemed necessary by the customer to perform an Earth Leakage test, the following advice should be adhered to. Note that not all PATs are capable of just measuring the leakage or allow you to set a pass limit and therefore may not be appropriate for this test.

⚠ WARNING

HIGH LEAKAGE CURRENT

Merrychef appliances are fitted with radio interference filters and inverter circuits which cause an increase in leakage current. The PAT may indicate an erroneous fail condition depending on its internal "pass"/"fail" settings. Please refer to the revised limits which apply to the specific Merrychef oven model.

Model	Model maximum limit applied with radio interference filter fitted
eikon e2s	10 mA

⚠ WARNING



Never touch the component under test while tests are being carried through.

- ▷ Call a trained authorized service agent if the oven under test still fails in order to check all earth connections and disconnect the radio interference filters before repeating the test if required.

Earth/Insulation test

Check that the following requirements have been met:

- The appliance has been disconnected from the power supply and protective measures have been taken to ensure the power cannot be switched on again.

1.  Connect the mains lead from the appliance to a Portable Appliance Tester.
2.  Connect the earth from the Portable Appliance Tester to the appliance.



3. Place the Portable Appliance Tester in an open area, such as the floor, away from any persons. Perform a Class 1 test in accordance with tester instructions.
- A PASS indicates the oven earthing circuit is functioning correctly.
 - If a FAIL is indicated (i.e. unit exceeds maximum limit), remove the casing of the appliance and check ALL earth connections. Then repeat the Class 1 test.

WARNING:
Never operate an appliance that has failed this test as it could be potentially dangerous.

Service Mode: Tests Menu

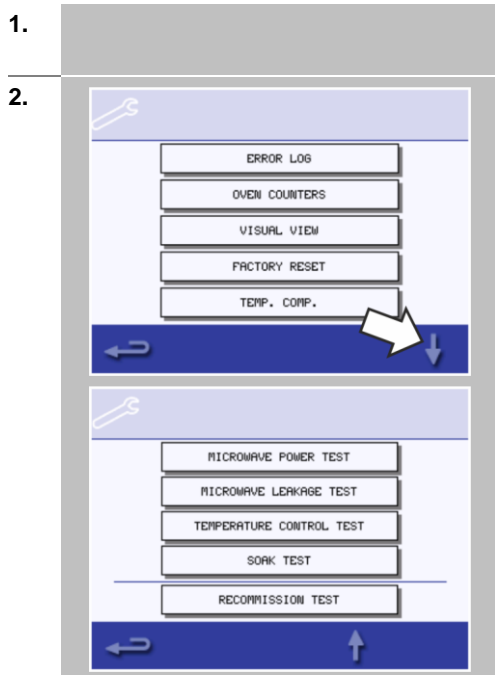

1. Enter Service Mode.
For details see "*Checking the condition of your appliance*".
2. Select the down arrow to display the individual tests for the appliance to perform.

Microwave Power test: Measuring the microwave power output of the magnetron(s)

Check that the following requirements have been met:

- The appliance is cool.

NOTE:

The power output is established under IEC 705 standard method which is only workable in laboratory controlled conditions. The power output is also affected by line voltage under load, so this test is an approximation only.



1. Enter Service Mode.
For details see "*Checking the condition of your appliance*".

<p>2.</p>		<p>Select 'Visual View' to check the cavity temperature reading is as close to 0°C as possible.</p>
<p>3.</p>		<p>Fill a microwave safe container (glass or plastic) with one litre (1.78 pints) of tap water at 20°C (68°F).</p>
<p>4.</p>		<p>Measure and record the water temperature in the container using a thermometer capable of reading ±0.1 degree increments.</p>
<p>5.</p>		<p>Place the container centrally into the cavity.</p>
<p>6.</p>		<p>Select 'Microwave Power Test' from the Service Mode tests (microwave power 100% for 63 seconds, fan minimum).</p>
<p>7.</p>		<p>When the countdown has finished, remove the container from the cavity. Immediately stir with a plastic implement and measure the water temperature.</p>

- | | | |
|----|--|---|
| 8. | | <p>Calculate the temperature rise of the water (end temperature minus the start temperature).
 The temperature rise should be 14.3°C (25.7°F) ±10% for the 1000W (1 magnetron) variant.
 The temperature rise should be 28.5°C (51.4°F) ±10% for the 2000W (2 magnetrons) variant.
 If the temperature rise is outside these limits check the microwave circuit and components.
 Replace the magnetron and/or high voltage diode board / rectifier if required.</p> |
|----|--|---|

Microwave Leakage test

Follow these instructions when measuring:

- Make sure that the survey meter you are using has been calibrated and is suitable for measuring frequencies of 2,450 MHz.
- Do not exceed meter full scale deflection. The leakage meter should initially be set to the highest scale, then adjusted down as necessary to ensure that low readings are measured on the most sensitive range.
- To prevent false readings, hold the probe on the grip provided and move at 2.5 cm/second.
- Always hold the probe at right angles to the oven and point of measurement, ensuring the probe is reading 50 mm from the test area.
- The leakage should not exceed 5 mW/cm².

- | | | |
|----|--|--|
| 1. | | Add 275 ml of cold water into a 600 ml microwave safe container. |
| 2. | | Place the 600 ml container in the centre of the cavity and close the door. |
| 3. |  <p>The screenshot shows a microwave control panel in service mode. At the top, there is a wrench icon. Below it is a list of test options: MICROWAVE POWER TEST, MICROWAVE LEAKAGE TEST (with a white arrow pointing to it), TEMPERATURE CONTROL TEST, SOAK TEST, and RECOMMISSION TEST. Below the list are two navigation buttons: a left arrow and an up arrow. The screen then displays 'MICROWAVE LEAKAGE TEST' at the top, followed by 'STATUS' and 'RUNNING...'. At the bottom of the screen, there is a red 'X' icon.</p> | Enter Service Mode on the screen and select 'Microwave leakage test' from the appliance tests. |

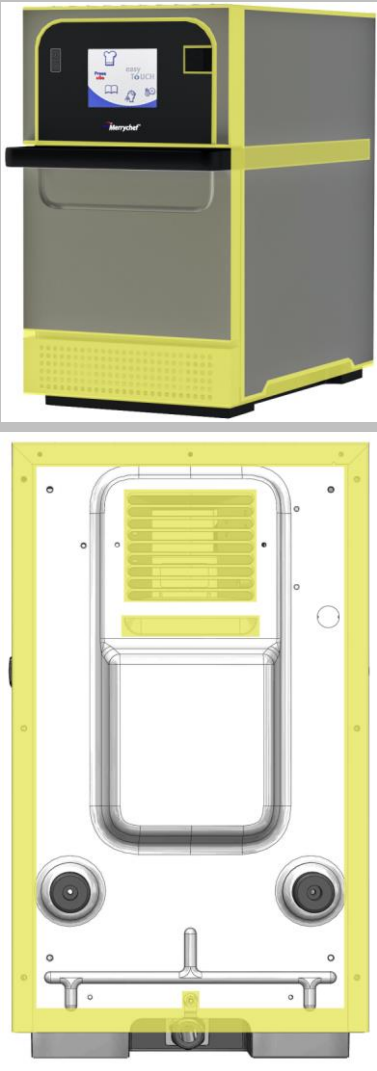
4.		Set the leakage meter to the appropriate scale/range.
5.		Move the survey meter probe across all casework joins and vent areas including those marked in yellow, shown opposite.
6.		When the magnetron circuit stops after 30 seconds, change the water and re-select the test to continue.
7.		Select the red 'X' on the display to stop the test at any time.
8.		<p>Readings must be below 5 mW/cm².</p> <p>CAUTION: If a level greater than 5 mW/cm² is observed, report this to the Merrychef Service Department immediately. Don't use the appliance hereafter.</p>
9.		Note any leakage that is observed in terms of the level and position on the appliance. Keep this information with the service documentation.

Temperature Control test: measuring the cavity temperature

NOTE:

Re-calibrating the temperature sensor / thermocouple with the SRB is normally only required when the thermocouple has been replaced or the appliance is under or over cooking.

1.



Place the probe of a temperature reader onto a heat sink or a metal plate in the centre of the oven cavity and close the door.

2.



Select 'Temperature Control Test' from the service mode tests. The cavity heats up and cycles at the maximum set point temperature over 30 minutes.

3.

Once the appliance is up to maximum temperature check for a stable temperature reading.

4.

Select the red 'X' to finish the test, if necessary.

- | | | |
|-----------|--|---|
| <p>5.</p> | | <p>If the temperature reading is different to the maximum set point, scroll up to select TEMP. COMP. (Temperature Compensation) and enter the password.</p> |
| <p>6.</p> | | <p>Enter the figure from the temperature reader on the keypad and select OK to calibrate the SRB to the temperature sensor (thermocouple).</p> |
| <p>7.</p> | | <p>Retest to check that the cavity temperature reading is the same as the oven maximum set point temperature.</p> |
| <p>8.</p> | | <p>If the temperature reading is stable repeat the Temperature Control Test procedure.</p> |

If the temperature reading is unstable:

1. Disconnect and isolate the appliance from the electricity supply.
Take protective measures to ensure the power cannot be switched on again.

2. Allow the appliance to cool down.
3. Remove the side and top panels of the casing.
4. Check the cavity temperature sensor wire and connections.
5. If the wire and connections are working properly replace the cavity temperature sensor (see “Replacing components” section of this manual).
6. Refit the panels of the casing.
Switch ON the appliance and repeat the test procedure as described above.
7. If the temperature is still unstable repeat steps 1 to 3, replace the SRB (see “Replacing components” section), repeat step 6.

NOTE: Reuse the existing PM (Personality Module) on the new SRB (enter serial number on reboot).

Soak test: checking the cavity integrity

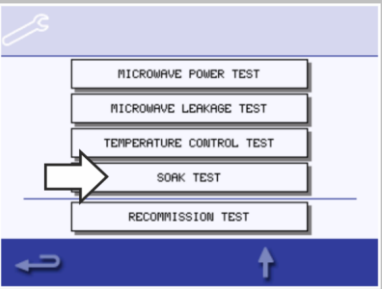
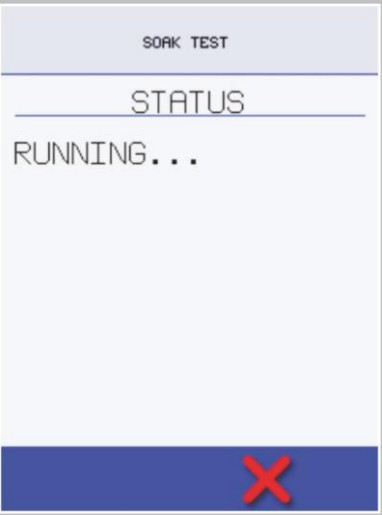
- | | | |
|----|---|--|
| 1. | | Place an oven/microwave safe container with approx. 2 litres of water into the cavity. |
| 2. |  | Close the appliance door and select 'Soak Test' from the Service Mode oven tests (maximum oven temperature, 50% microwave power, maximum fan speed). |
| 3. |  | Run the test (30 minutes), carefully checking the appliance casing, joints and door seal for signs of steam or water escaping from the cavity. |
| 4. | | If necessary, rectify any leaks and repeat the test. |
| 5. | | Safely remove the container from the cavity. |

10.4 High voltage components (casing removed)

High Voltage Transformer test

Ensure the following requirements have been met before starting the test:

- The appliance has been disconnected from the power supply and protective measures have been taken to ensure the power cannot be switched on again.
- The appliance is cool.
- The high voltage capacitors are discharged before commencing work.
- Anti-static precautions have been taken.
- The casing of the appliance has been removed.

⚠ DANGER

High voltages and large currents are present at the high voltage capacitor.

It is very dangerous to work near this part when the oven is on.

NEVER make any voltage measurements at the high voltage circuits, including the magnetron filament.

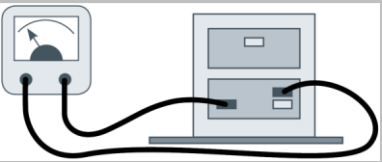
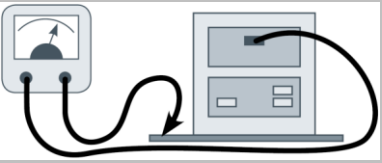
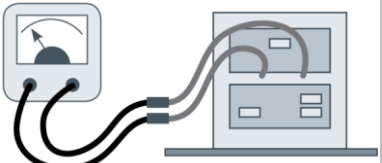
1.		Remove all connections from the transformer.
2.		Using a Digital Multi-Meter (DMM), check the resistance of the windings. Results should be as follows:
3.		Mains winding between tags, approx. 1.1 Ω.
4.		High Voltage winding, approx. 60 Ω.
5.		Filament winding between terminals, less than 1 Ω.
6.		Using a megger, test the insulation resistance between: <ul style="list-style-type: none"> • Primary winding and chassis. Pass if reading is over 10 MΩ • Filament winding and chassis. Pass if reading is over 10 MΩ NOTE: One end of the High Voltage winding is connected to the chassis, so this is not tested.

High Voltage Diode test

Ensure the following requirements have been met before starting the test:

- The appliance has been disconnected from the power supply and protective measures have been taken to ensure the power cannot be switched on again.
- The appliance is cool.
- The high voltage capacitors are discharged before commencing work.
- Anti-static precautions have been taken.
- The casing of the appliance has been removed.

1.

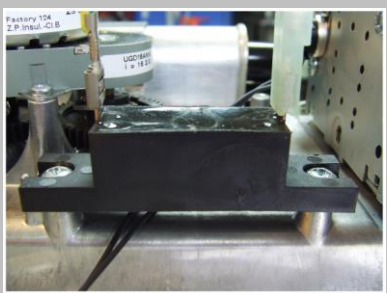

Remove all connections from the high voltage diode.

2.



Using a megger, test for continuity in both directions.

Results should be as follows:

- Open circuit both ways - FAIL
- Conducts one-way only - PASS
- Short circuit both ways - FAIL
- Conducts one way, leaks the other - FAIL

High Voltage Capacitor test

Ensure the following requirements have been met before starting the test:

- The appliance has been disconnected from the power supply and protective measures have been taken to ensure the power cannot be switched on again.
- The appliance is cool.
- The high voltage capacitors are discharged before commencing work.
- Anti-static precautions have been taken.
- The casing of the appliance has been removed.

⚠ DANGER

High voltages and large currents are present at the high voltage capacitor.

It is very dangerous to work near this part when the oven is on.

NEVER make any voltage measurements at the high voltage circuits, including the magnetron filament.

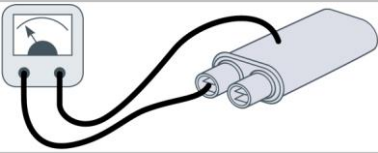
1.		Remove all electric connections from the high voltage capacitor.
2.		Using a Digital Multi-Meter (DMM), check for continuity: Results should be as follows:
3.		Connect the DMM to both terminals of the high voltage capacitor. The test is passed if the DMM display reads approx. 10 MΩ.
4.		Connect the DMM to one terminal and the metal outer case of the high voltage capacitor. The test is passed if the DMM display reads "open circuit". Repeat the test for the other terminal and the metal outer case.
5.		Using a megger, test the insulation resistance between both terminals and the metal outer case of the high voltage capacitor. The test is passed if the megger display reads over 100 MΩ.
6.		Repeat the whole test for the second high voltage capacitor (2000W variant only).

High Voltage Magnetron test

Ensure the following requirements have been met before starting the test:

- The appliance has been disconnected from the power supply and protective measures have been taken to ensure the power cannot be switched on again.
- The appliance is cool.
- The high voltage capacitors are discharged before commencing work.
- Anti-static precautions have been taken.
- The casing of the appliance has been removed.

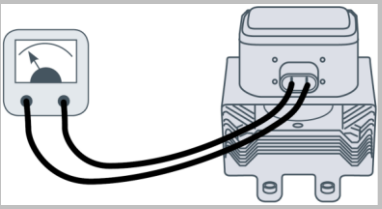
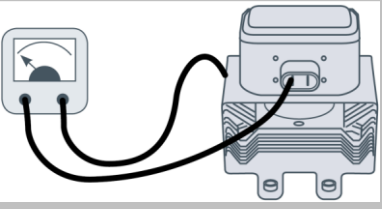
1.		Remove all electric connections from the magnetron.
2.		Using a megger, check for continuity. Results should be as follows:
3.		Connect the megger to both filament terminals of the magnetron. The test is passed if the megger display reads 1 Ω or less.
4.		Connect the megger to one filament terminal and the metal outer case of the magnetron. The test is passed if the megger display reads "open circuit". Repeat the test for the other filament terminal and the metal outer case.
5.		Repeat the whole test for the second magnetron (2000W variant only).

10.5 Mains voltage components (casing removed)

Convection fan: motor

The convection fan motor is a 3-phase AC motor having a maximum speed of 7200 rpm controlled by a motor speed controller.

The windings are thermally protected and in the event of a thermal fault a trip inside the motor will operate and shut down the motor speed controller.

Convection fan: motor speed controller

The convection motor speed controller provides a 3-phase AC switched mode drive to the convection motor and is controlled by a 0 - 10 Volt signal from the SRB.

This allows the motor to be adjusted from approximately 1500 rpm to 7000 rpm in steps of 5%.

- Door open, 1500 rpm (20% @ 2V).
- Door closed (not cooking), 2190 rpm (31% @ 3.1V).
- Door closed (cooking), speed as specified by program or setting up to a maximum of 7000 rpm (100% @ 10V).

Convection fan: LED status display

- Inverter Off / No supply, LED OFF.
- Power On / Ready, LED flashes ON/OFF 1x per second.
- Inverter Running, LED ON continuously.
- General Warning, LED flashes ON/OFF 2x per second.
- Fault Condition, LED flashes ON/OFF 10x per second.

Convection fan: motor and motor speed controller tests

Ensure the following requirements have been met before starting the test:

- The appliance has been disconnected from the power supply and protective measures have been taken to ensure the power cannot be switched on again.
- The appliance is cool.
- The high voltage capacitors are discharged before commencing work.
- Anti-static precautions have been taken.
- The casing of the appliance has been removed.

Check the following:

1.		Electrical supply into motor controller.
2.		Three phase connections to convection fan motor.
3.		Motor speed controller (convection fan) connections to SRB.
4.		Convection fan motor thermal cut-out (short circuit).
5.		Convection fan motor rotates freely / not seized.
6.		Convection fan motor winding resistances: <ul style="list-style-type: none"> ▪ Blue-Black 3-4 Ω ▪ Black-Brown 3-4 Ω ▪ Brown-Blue 3-4 Ω ▪ Black or Brown or Blue to Earth (open circuit).

11 Firmware





Purpose of this chapter

This chapter informs about the correct procedure to check and update the firmware of the appliance.

	Page
Firmware Updates	116

11.1 Firmware Updates

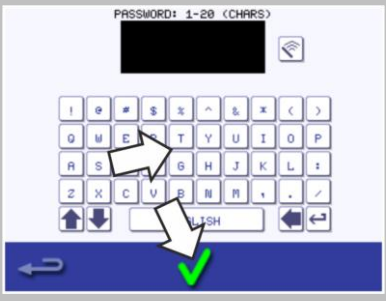
Overview

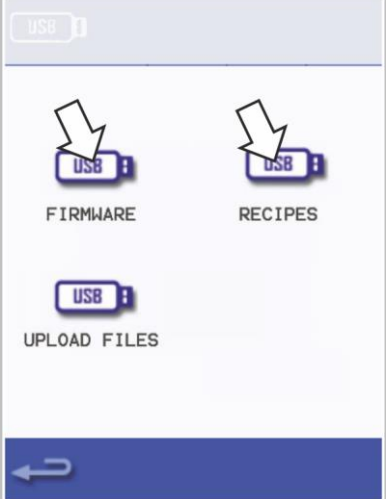
- | | | |
|----|---|---|
| 1. |  | Switch on the oven. |
| 2. |  | Tap the top right hand corner of the screen. |
| 3. |  | Enter the correct password (the default password is "MANAGER") and select the green check mark. |
| 4. |  | Select the USB symbol. |
| 5. |  | <p>Select one of the USB options:</p> <ul style="list-style-type: none"> ▪ 'Firmware' for QTS & SRB updates ▪ 'Recipes' for icons. <p>Install the SRB update first, the QTS update second and any icons third.</p> <p>Alternatively, if you have the Autoupd.ate file present on the USB be aware that all files of your USB will be loaded and overwrite the existing files.</p> <p>Save the menu files before uploading files.</p> <p>If you have a menu file on your USB memory stick then the menu of the appliance will be overwritten.</p> <p>If you have no menu file on your USB memory stick the menu of the appliance stays as it is.</p> |

6.

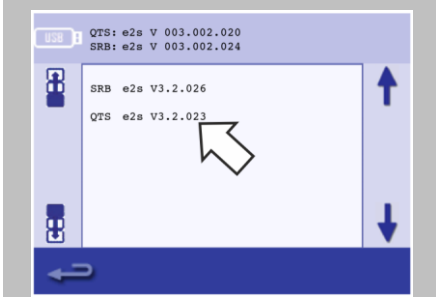

Select the firmware to install and select the green check mark to confirm.

7.

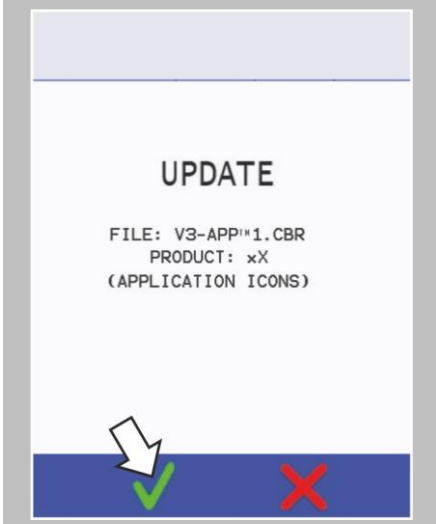

The update screen displays the file version and product. Select the green check mark to confirm the installation.

Requirement:

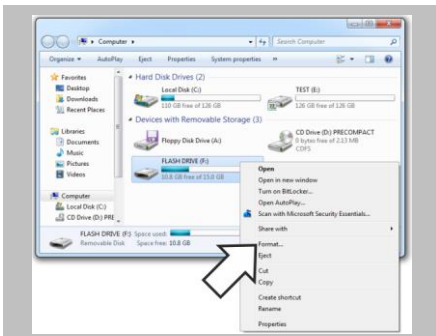

To format a USB memory stick, place it in a PC USB slot, select 'Computer' and right click on the USB memory stick symbol. Select 'Format' and select FAT (Do NOT select FAT 32).

NOTE:

This will erase all data on the USB memory stick.

Procedure:

1.

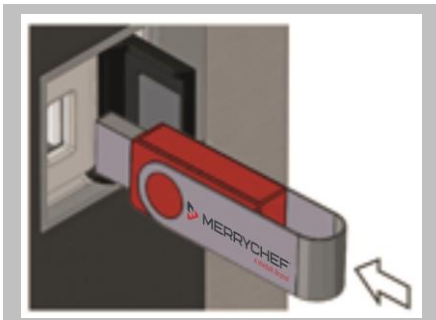

With the oven switched OFF, open the cover of the USB port and insert the USB memory stick into the slot. The USB memory stick should be formatted to FAT with firm-ware loaded.

NOTICE:

Do not remove the USB memory stick during the download sequence as this could corrupt the data transferred from the USB stick.

2.



Switch ON the oven.
Tap the top right hand corner of the screen to bypass the pre-heat stage.

3.



Enter the password (default password is "MANAGER").
Select the green check mark to display the Settings menu.

4.



Select the USB symbol.

5.



Once the USB memory stick has stopped flashing, select the 'Firmware' USB symbol.

6.

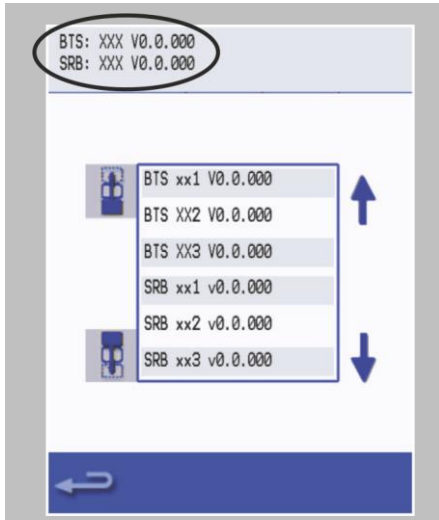

The current QTS (Quick Touch Screen) and SRB (Smart Relay Board) firmware versions are displayed at the top left of the screen.

SRB firmware update

6.

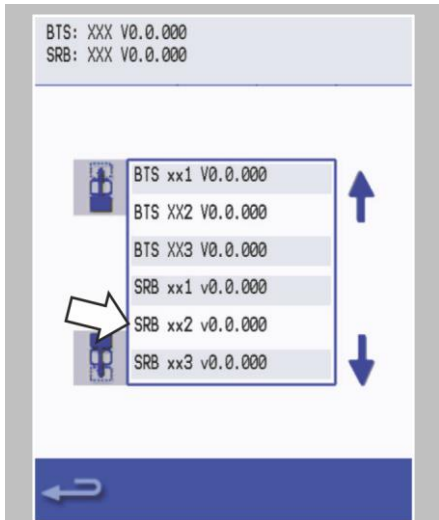

Select the 'SRB' file with the correct file version number.

NOTE:

A tinted band over a file name indicates the file is not valid for your oven.

7.

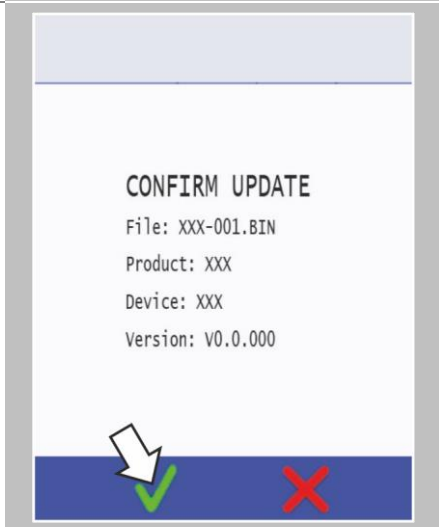

Check if the file information shown is correct before selecting OK.
If not select 'X' and locate the correct file.

8.

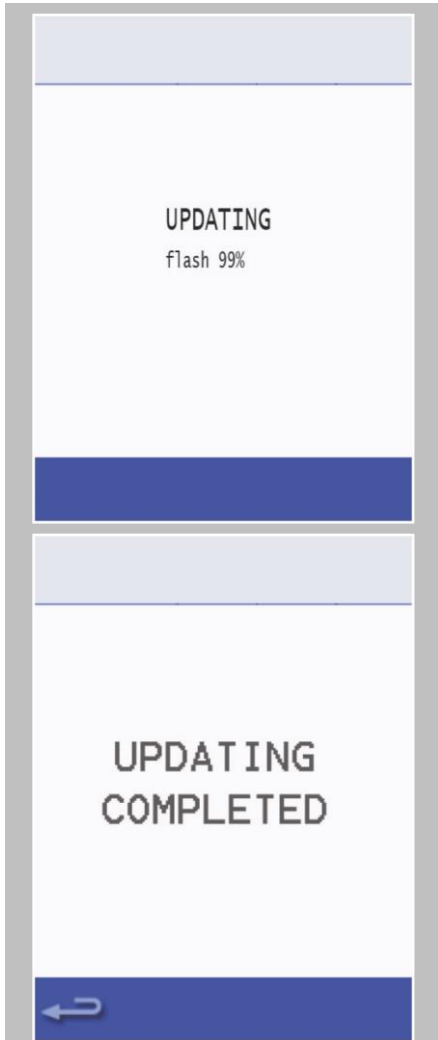

The SRB file is checked and the download progress from the USB is displayed followed by the update status and confirmation screens.

NOTE:

Wait until all files have been loaded. Do not touch the oven until the end of the downloading process.

9.



When the download process is complete press the return arrow and select the QTS file and repeat.

10.



When the QTS download has been completed, the oven will reboot and display a flash screen as it updates.

QTS firmware update

13.

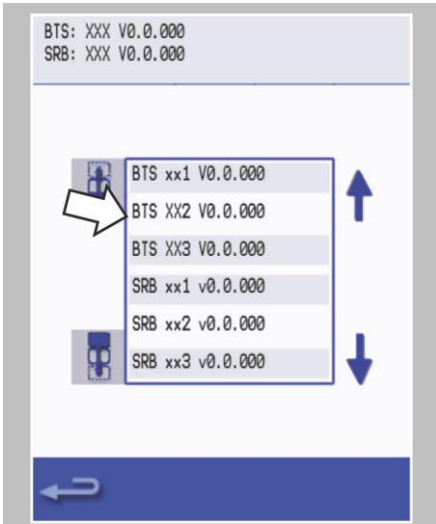

Select the 'QTS' file with the correct file version number.

NOTE:

A tinted band over a file name indicates the file is not valid for that appliance.

14.

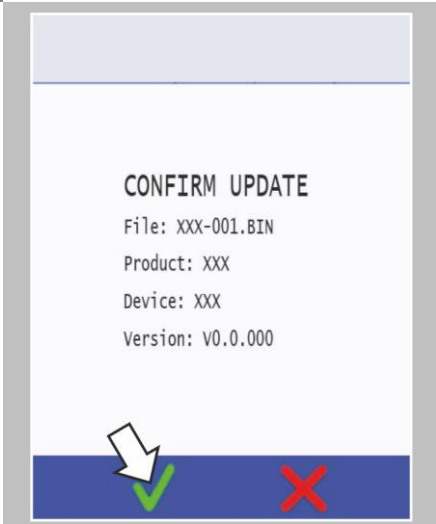

Check if the file information shown is correct before selecting OK. If not, select 'X' and locate the correct file.

15.

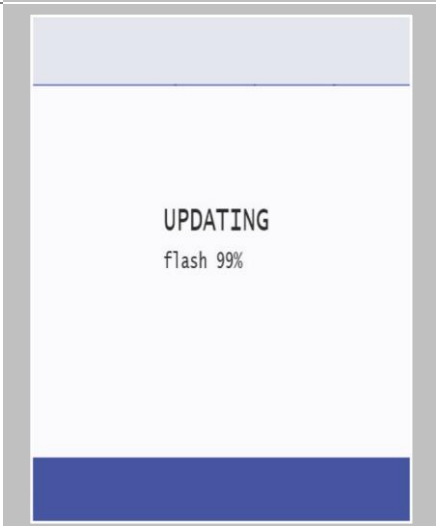

The file update progress is displayed. At 50% the cooling fan stops operating, after 100% various screen displays appear as the software reboots.

16.



Check if the screen shows the correct QTS version.
If not, repeat the process using the correct file.

17.

Remove the USB memory stick and keep it in a safe place.

Download Procedure

NOTICE

Do not remove the USB memory stick during the download sequence as this could corrupt the USB data.

IMPORTANT:

Downloading from a USB memory stick will clear all existing programs.

Only use an empty USB memory stick formatted as FAT16 (default) or FAT32.

Copy the following firmware files to the ROOT directory of the USB memory stick:

- QTS-eX-XXX-VX.X.XX.BIN
- SRB-eX_X_X_XXX.BIN
- VX-APP-eX.CBR
- Autoupd.ATE

For update A) follow all instructions:

For update B) follow the first two instructions:

1.

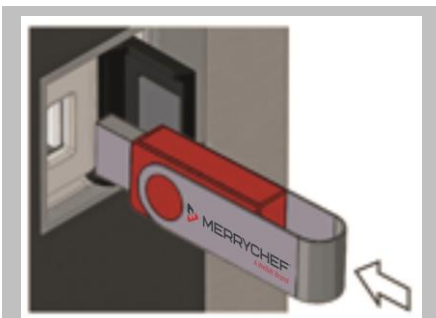

With the oven switched OFF, open the cover of the USB port and insert the USB memory stick into the slot.

2.



Switch ON the oven.

3. Tap the top right of the screen to bypass the preheat stage.

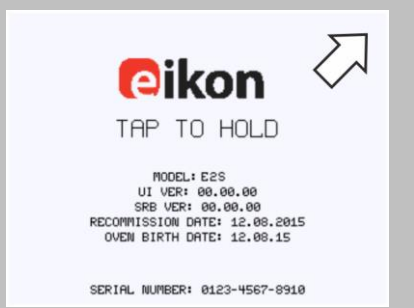

4. Enter the password and select OK to display the settings menu.

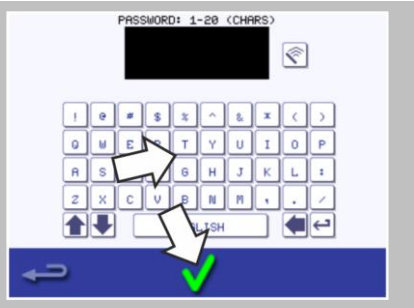

5. Select the USB symbol.



6. Select the 'Firmware' USB symbol.

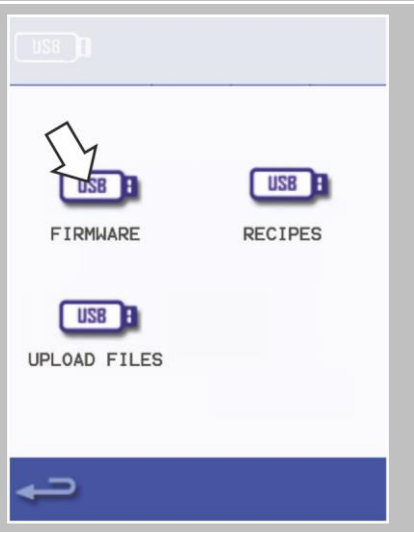

7.

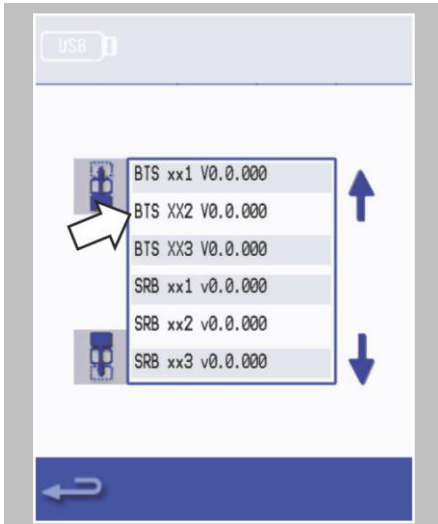

Select the 'QTS' file with the correct file version number.

NOTE:

A tinted band over a file name indicates the file is not valid for that appliance.

8.

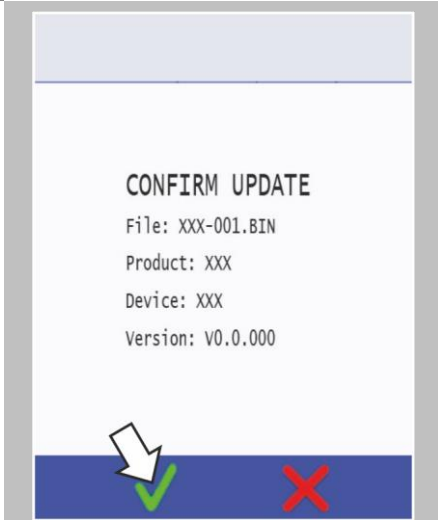

Check the file information shown is correct before selecting the green check mark. If not, select 'X' and locate the correct file.

9.

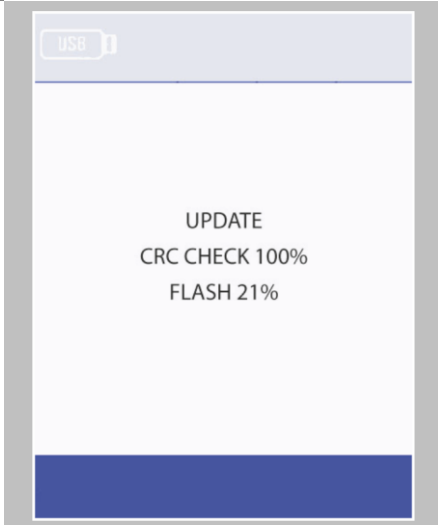

The CBR file is checked and the download progress from the USB memory stick is displayed followed by the update status and confirmation screens.



10.



The QTS, SRB and Application Icon files then download automatically showing the progress, status and reboot confirmation screens for each file update.

11.

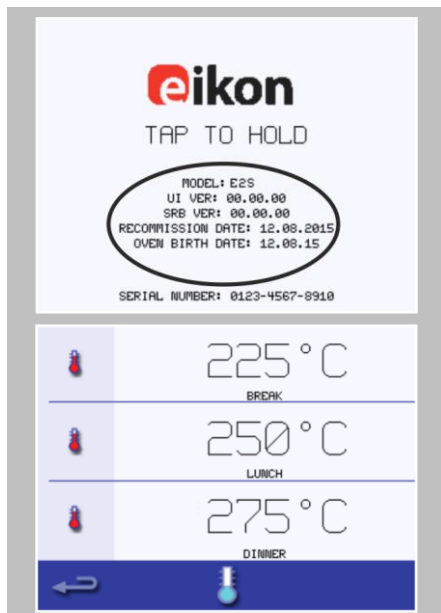

On completion the start up screen is displayed showing the updated firmware versions followed by the pre-heat temperature screen.

Confirming the firmware update

After an update of the appliance firmware certain files are copied back to the USB memory stick. You can check if the file transfer was successful with the following procedure:

1. Load the files from the USB memory stick to a computer.
2. Open the update (UPDATE.txt) file.
3. A firmware update is confirmed below the serial number of the appliance with 'updated' following the QTS/SRB firmware.

Load only the specific files for the stage 3.1 upgrade onto the USB memory stick:

- BTS/QTS - (model type) V.003.000.001
- SRB - (model type) V.003.000.001
- Latest menu file xxxxxxxxxx



NOTE:

Load only the correct menu files onto the USB memory stick and not single menus.

PM (Personality Module) replacement - firmware update

NOTE:

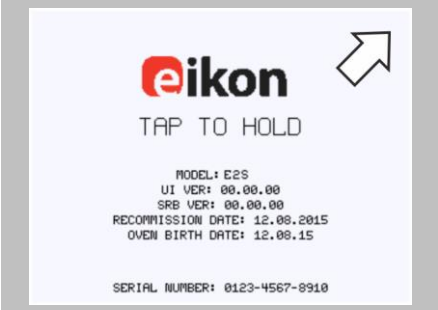
- The Personality Module on the SRB contains the firmware.
- The Personality Module on the QTS contains the firmware, serial number of your appliance, temperature calibration, cooking profiles, application icons and the recipe images.

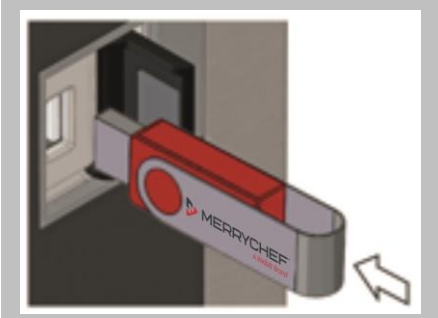
1.  With a new Personality Module fitted and casing refitted, switch on the appliance and tap the screen to hold and check the QTS and SRB versions are the latest release. If not, execute a firmware update using the latest versions.
2.  Tap the top right of the screen to bypass the preheat stage.
3.  Enter the service password and select OK to display the settings menu.
4.  Select the USB symbol.
5.  Open the cover to the USB port and insert the USB memory stick into the slot.

NOTE:
The USB memory stick may take several seconds to load before the screen will respond.

6.



Once the USB memory stick has stopped flashing, select the required "USB Recipes" symbol.

7.

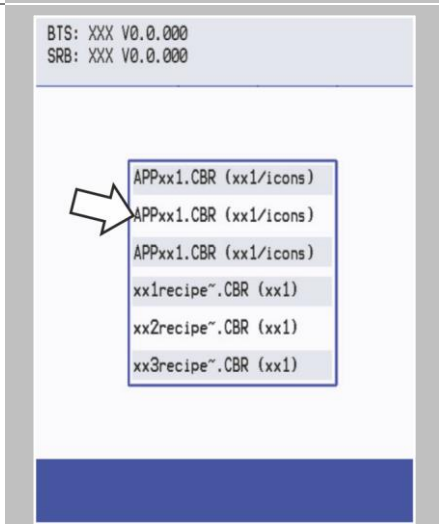



Select the application icons file to download.

NOTE:
A tinted band over a file name indicates the file is not valid for that appliance.

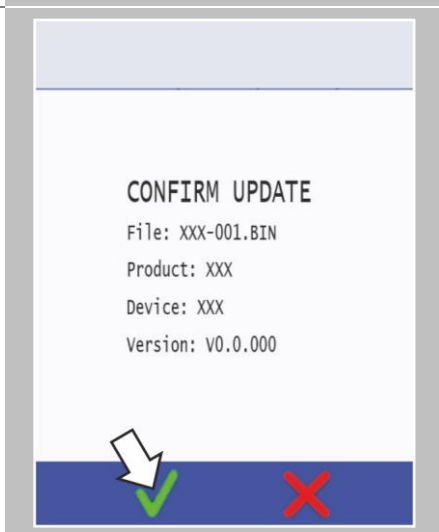
8.

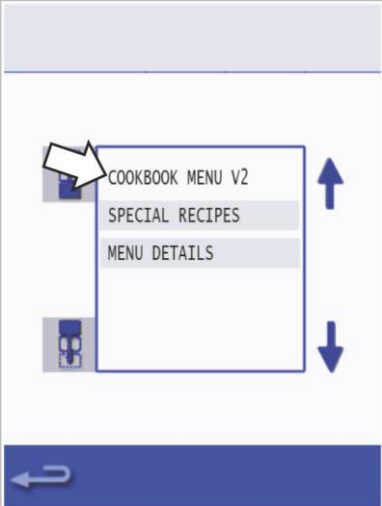

Check the file information shown is correct before selecting OK. If not, select 'X' and locate the correct file.

- | | | |
|-----|---|---|
| 9. |  | When completed, select menu file to load the cooking profiles. Once the cooking profiles are loaded the appliance restarts. |
| 10. |  | Enter the date and time settings. |
| 11. | | Enter the serial number of the appliance (found on the rating plate at the rear casing). |
| 12. |  | Switch the appliance OFF/ON. |
| 13. | | Remove the USB memory stick and keep it in a safe place. |

12 Replacing components

Purpose of this chapter

This chapter contains information on how to remove and fit components of the oven.

Contents

This chapter contains the following topics:

	Page
Safe working when replacing appliance parts	132
Overview	134
Removing / fitting the casing	139
Removing / fitting the door assembly	142
Replacing a magnetron	147
Replacing the cooling fan	152
Replacing the QTS (Quick Touch Screen) assembly	154
Replacing the SRB (Smart Relay Board)	158
Replacing the touchscreen overlay	160
Adjusting the door microswitches / interlocks	162
Replacing the stirrer motor	164
Replacing the convection fan motor	168
Replacing a transformer (high voltage)	171
Removing the convection fan motor speed controller	174
Overview - further components	176

12.1 Safe working when replacing appliance parts

For your safety when replacing appliance parts

Before starting service / repair work, it is essential that you familiarize yourself with the rules and hazard warnings specified and follow the instructions given there.

Eligibility of personnel for removal / fitting of appliance parts

Only qualified personnel from an authorized service company are permitted to remove and fit components of the microwave combination oven.

Rules for setting up the appliance safely

To prevent hazards that arise from the installation site and environment of the appliances, the rules for setting up the appliance safely must always be observed; see '*Requirements relating to the operating environment of the microwave combination oven*' on page 23 in the Installation and Operating Manual.

Live components

DANGER

Risk of electric shock from live parts

When the appliance is not connected to an equipotential bonding system, there is a risk of electric shock from touching live parts.

- ▷ Make sure that any work on the electrical system is performed solely by a qualified electrician from an authorized service company.
- ▷ Make sure that the electrical connections are intact and connected securely before putting the appliance into use.
- ▷ Before preparing the appliance for use, make sure that the appliance, including all metallic accessories, is connected to an equipotential bonding system.

Moving heavy loads

WARNING

Risk of injury from lifting incorrectly

When lifting the appliance, the weight of the appliance may lead to injuries, especially in the area of the torso.

- ▷ Use a forklift truck or pallet truck to place the appliance in the installation position or to move it to a new position.
- ▷ When shifting the appliance into the correct position, use enough people for the weight of the appliance when lifting it (value depending on age and gender). Observe the local occupational safety regulations.
- ▷ Wear personal protective equipment.

Sharp-edged sheet-metal parts

WARNING

Risk of cuts from sharp-edged sheet-metal parts

Working with or behind sharp-edged sheet-metal parts may result in cuts to hands.

- ▷ Exercise caution.
- ▷ Wear personal protective equipment.

Hot surfaces

▲WARNING

Risk of burns from high temperatures inside the cavity and on the inside of the appliance door

- ▷ You may get burnt if you touch any of the interior parts of the cooking chamber, the inside of the appliance door or any parts that were inside the oven during cooking.
- ▷ Before starting servicing and repair work, wait until the cooking chamber has cooled to below 50°C / 122°F or use the 'Cool-Down' function to cool the cooking chamber.
- ▷ Wear personal protective equipment.

Live components

▲DANGER

Risk of electric shock from live parts

When the covers of the microwave combination oven are removed, there is a risk of electric shock from touching live parts.

- ▷ Make sure that any work on the electrical system is performed solely by a qualified electrician from an authorized customer service office.
- ▷ Before removing the covers:
 - Switch the appliance off and disconnect the plug from the wall socket.
 - Turn off the isolator switch to disconnect fixed wired appliances and lock-off.
 - Take protective measures at every power switch to ensure that the power cannot be switched on again.
 - Always discharge the high voltage capacitors before working on the appliance using a suitably insulated 10MΩ resistor.
 - Make sure that the appliance is de-energized.
- ▷ Make sure that the electrical connections are intact and connected securely before you reconnect the appliance to the power supply.
- ▷ Before putting the appliance back into operation, make sure that the appliance, including all metallic accessories, is connected to an equipotential bonding system.

Microwave emissions

▲WARNING

Risk of burns from microwave emissions

- ▷ Do not become exposed to emissions from the microwave generator or parts conducting microwave energy.
- ▷ Never operate an appliance that has failed the "Microwave Leakage test".

Fire / smoke in the appliance

▲WARNING

Risk of fire and/or smoke

Flames and/or smoke may come out of the oven when switching it on after service/repair. This can be caused by a defective electrical component or electrical connections (wiring) that have been refitted incorrectly.

- ▷ Switch off the oven.
- ▷ Disconnect/isolate the oven from the electrical supply.
- ▷ Keep the oven door closed to stifle any flames.

12.2 Overview

View: left hand side

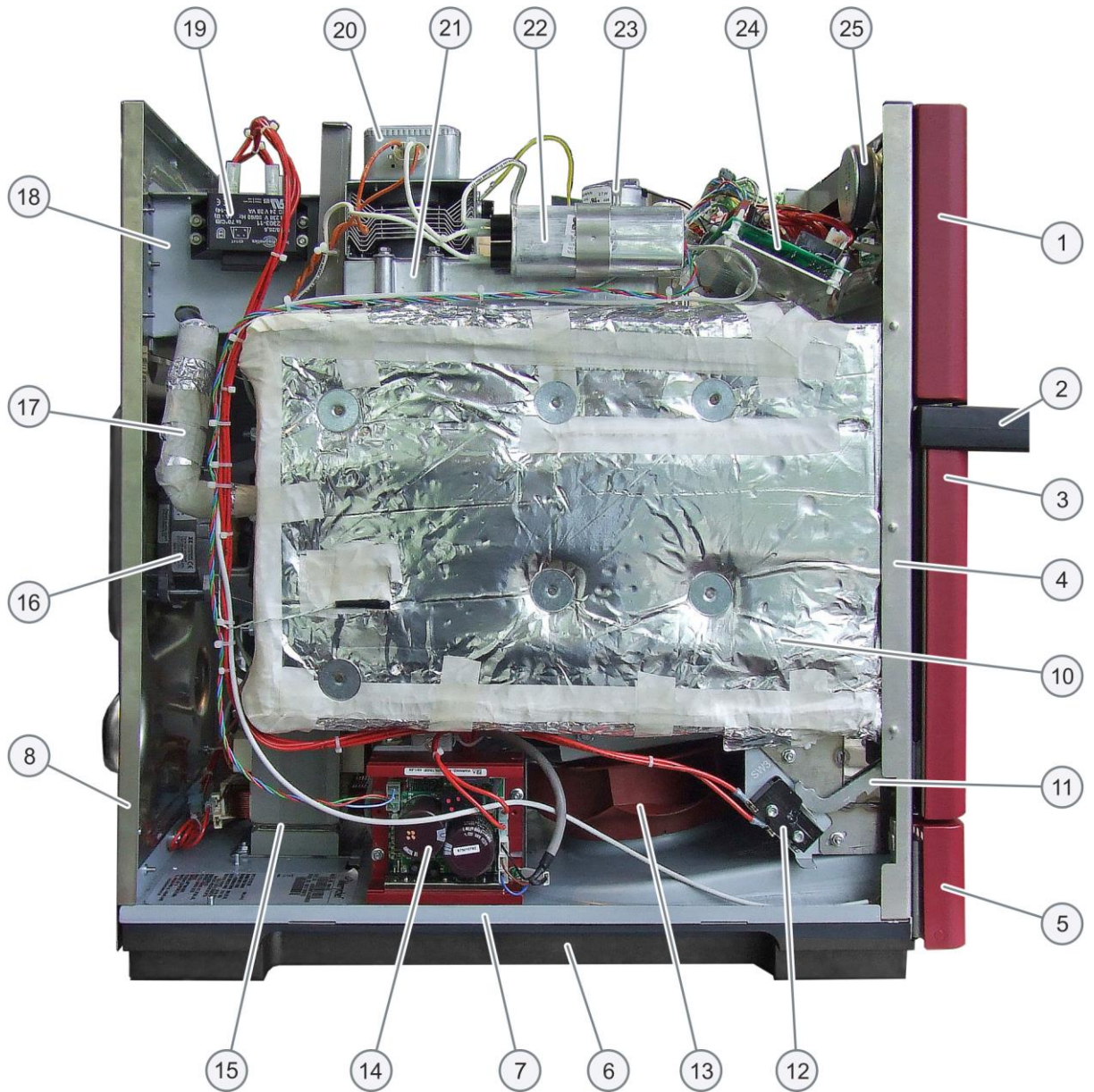

View: right hand side

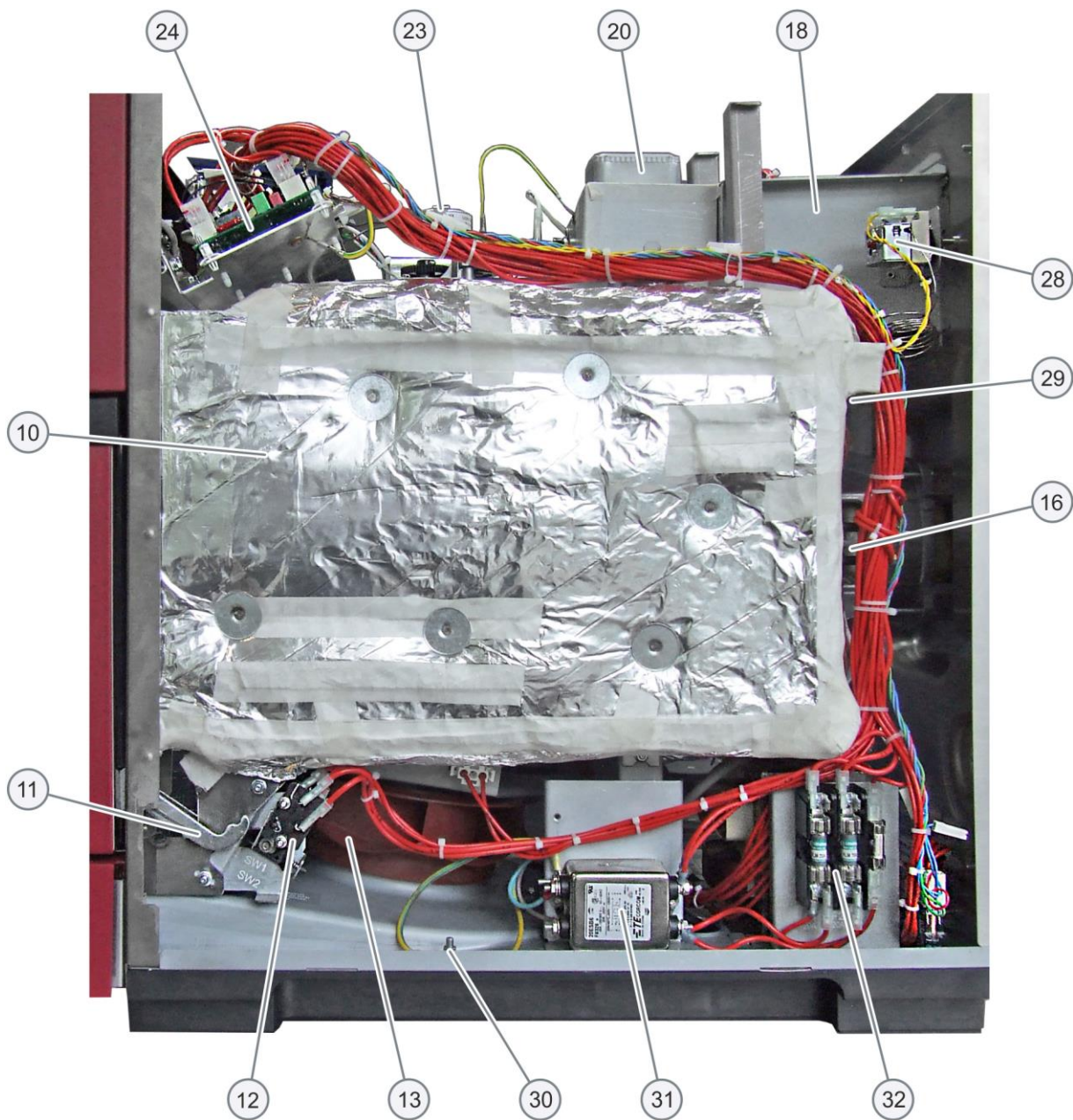

View: rear side

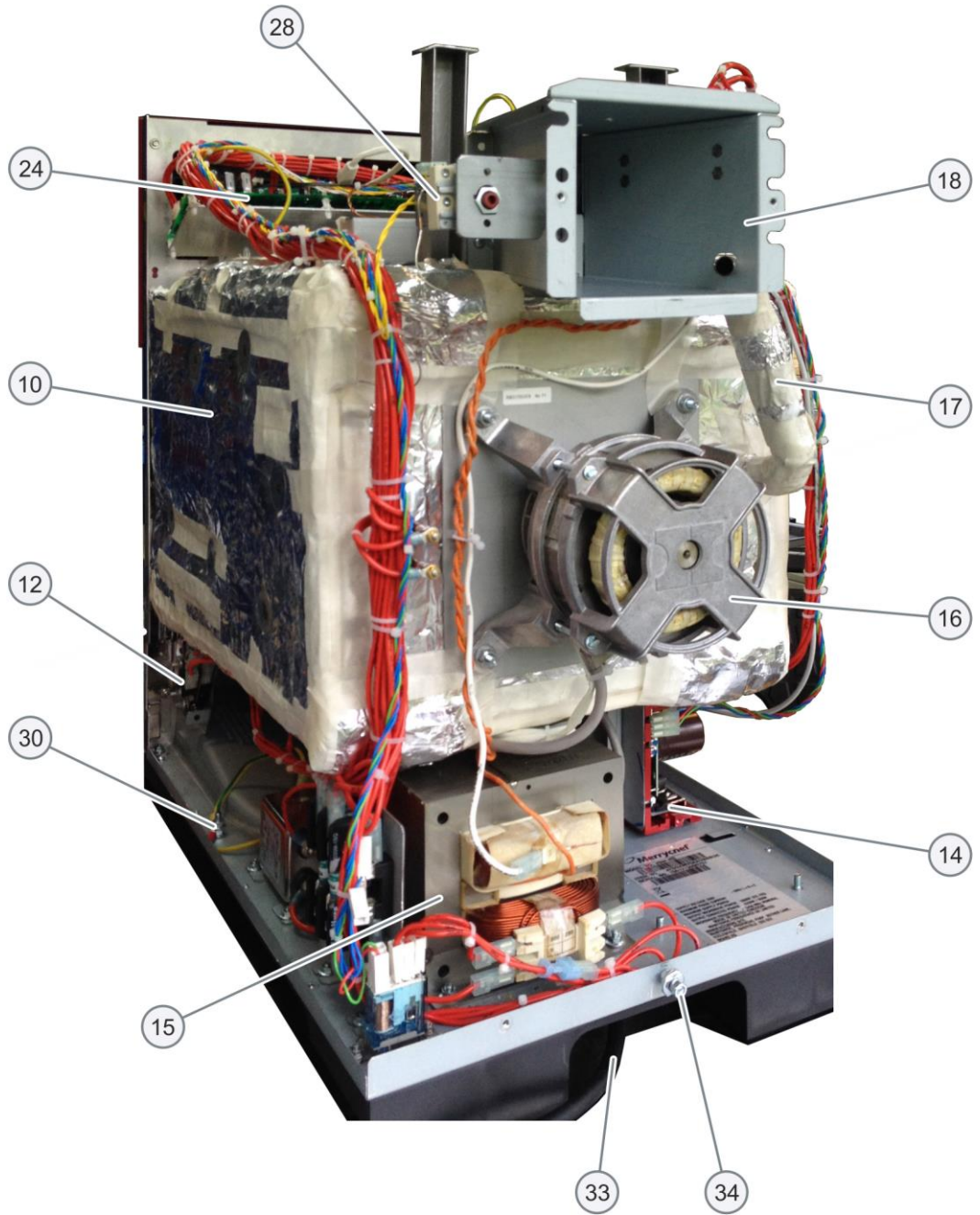

Component List

Item	Name	Function
1	Front panel	The front panel houses the touchscreen and the QTS assembly.
2	Door handle	Open the oven door using the door handle. Never use the door handle to lift the appliance.
3	Door cover panel	The door cover panel can be detached for accessing the door hinge assembly.

Item	Name	Function
4	Frame	The front, top, side and back panels of the casing and the oven door are mounted to the metal frame.
5	Air filter faceplate	The faceplate can be tilted to access the air filter.
6	Foot	The oven rests on a high quality plastic foot extending over the whole length of the appliance.
7	Base plate	The metal base plate carries all oven components.
8	Back panel	The back panel shows a grille permitting ventilation of the oven interior.
9		
10	Cavity	The cavity (cooking chamber) for cooking food can be accessed by opening the oven door.
11	Door hinge assembly	The door hinges interact with the microswitches / interlocks.
12	Door microswitch(es) / interlock(s)	The microswitches / interlocks are connected to the door hinges and switch off the magnetron(s) when the oven door is opened.
13	Cooling fan	The cooling fan pulls air through the air filter into the interior of the casing in order to cool the electrical components.
14	Convection (hot air) fan motor speed controller	This component controls the speed of the convection fan motor depending on specific oven settings.
15	Transformer (high voltage) (2000W e2s variant: 2x)	A high voltage transformer feeds a magnetron.
16	Convection (hot air) fan motor	The convection fan motor is controlled by the speed controller and drives the convection fan.
17	Exhaust pipe	The exhaust pipe leads excessive steam from the cavity to the cooling duct and the rear air outlet of the oven.
18	Cooling duct	The cooling duct leads heat generated by the magnetron(s) to the rear of the oven.
19	Transformer (low voltage - SRB)	The low voltage transformer feeds the SRB.
20	Magnetron (high voltage) (2000W e2s variant: 2x)	A magnetron generates microwaves.
21	Waveguide (2000W e2s variant: 2x)	A waveguide leads microwaves from a magnetron into the cavity.
22	Capacitor (high voltage) (2000W e2s variant: 2x)	The capacitor completes the magnetron circuit for required high voltage.
23	Stirrer motor (2000W e2s variant: 2x)	A stirrer motor turns a stirrer distributing microwave energy in the cavity.
24	Smart Relay Board (SRB)	The SRB controls all electrical oven components.
25	Loudspeaker	The loudspeaker produces sound signals (e.g. cooking process completed) and can be deactivated.
26	Diode (high voltage) (2000W e2s variant: 2x)	The diode completes the magnetron circuit for required high voltage.
27		
28	Cavity thermostat (cavity overheat stat)	The thermostat continuously measures the temperature in the cavity and prevents it from overheating.
29	Cavity temperature sensor wire (thermocouple) entering the cavity	The sensor wire extends between the thermostat and the interior of the cavity.
30	Protective earth	Some components are earthed at the metal base plate of the oven.

Item	Name	Function
31	Electromagnetic Compatibility (EMC) Filter (2000W e2s variant: 2x)	EMC filters reduce the transfer of electromagnetic noise between the drive (convection fan motor and motor speed controller) and the mains power supply.
32	Fuses	The fuses protect the oven from high voltages/currents.
33	Gland power supply cable	
34	Equipotential bonding connection (CE appliances only)	This is an electrical connection that ensures that the frames of electrical equipment and any external conductive components are at an equal (or practically equal) potential.

Tools required

- M5.5 hex socket wrench / nut runner
- M7 hex socket wrench / nut runner
- M7 hex socket wrench / ring spanner
- M8 hex socket wrench / nut runner
- Stanley knife (for cutting tape)
- Long handled Pozidriv screwdriver PZ1
- Long handled Pozidriv screwdriver PZ2
- Flat screwdriver or lever
- Pliers (or M14 ring spanner)
- Two metal pins (length: 10 mm / 0.4 in)
- Hammer (for removing pressed screws from a spare magnetron)

12.3 Removing / fitting the casing

Tools required

M5.5 hex socket wrench

Requirements

Check that the following requirements have been met:

- The appliance has been disconnected from the power supply and protective measures have been taken to ensure the power cannot be switched on again.
- The appliance is cool.
- The high voltage capacitors are discharged before commencing work.
- Anti-static precautions have been taken.

Removing the panels of the casing

Overview of all M5.5 hex head flange bolts securing the panels of the casing.

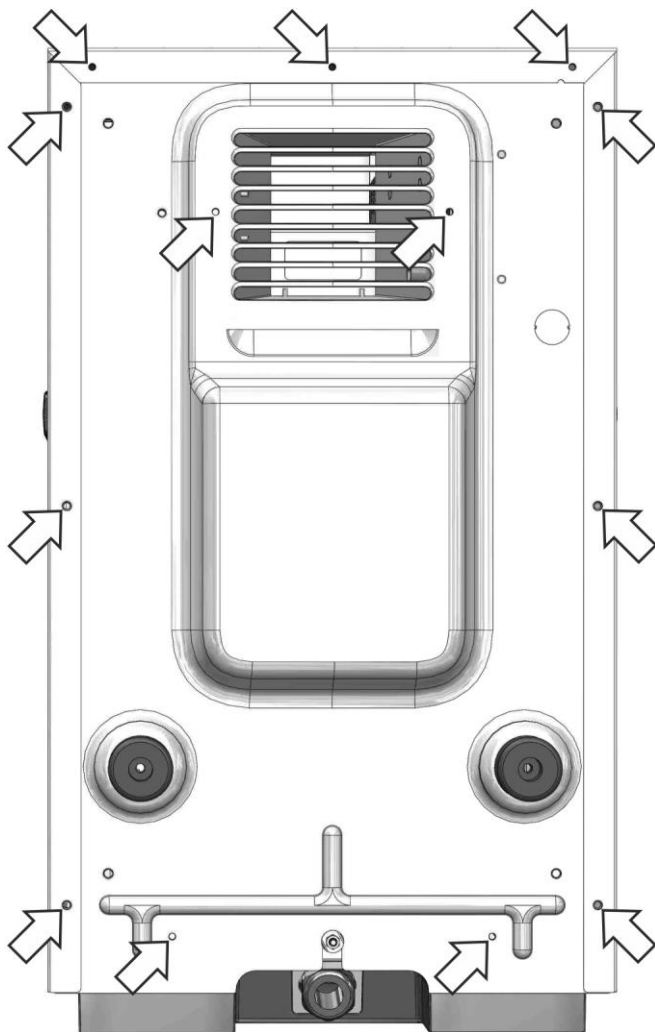

1.

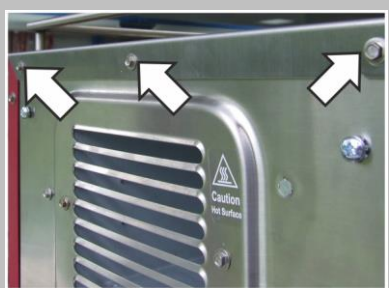

Remove top panel first.
Unfasten three M5.5 hex head flange bolts at the back panel of the appliance attaching the top panel to the back panel.
Slide the top panel towards the back of the appliance and remove it.

2.



Removing the side panels:
Unfasten six M5.5 hex head flange bolts (three per side) at the back panel of the appliance attaching each side panel to the back panel.
Slide the left and/or right side panel towards the back of the appliance and remove it/them.

3.



Removing the back panel:
Unfasten four M5.5 hex head flange bolts attaching the back panel to the cooling duct (two bolts) and bottom panel (two bolts) of the appliance.
Move the back panel up and remove it.

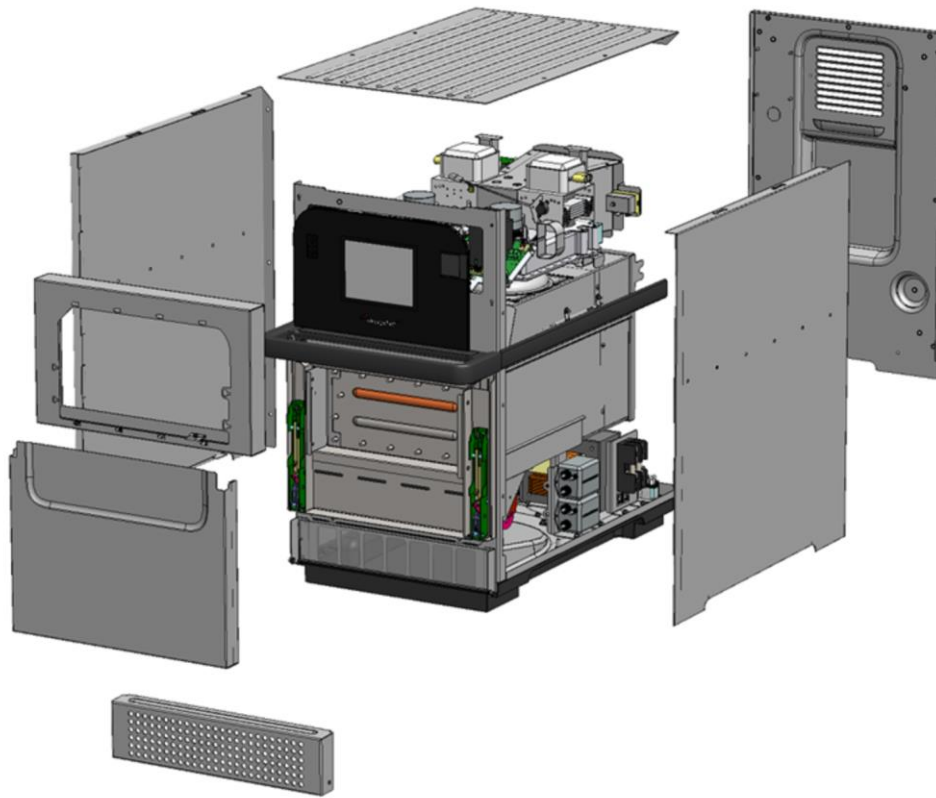

Fitting the panels of the casing

Follow the steps in the reverse order to fit the panels of the casing.

12.4 Removing / fitting the door assembly

Component



Tools required

- Two metal pins (length: 10 mm / 0.4 in)
- M5.5 hex socket wrench
- M8 hex socket wrench

Requirements

- Check that the following requirements have been met:
- The appliance has been disconnected from the power supply and protective measures have been taken to ensure the power cannot be switched on again.
 - The appliance is cool.
 - The high voltage capacitors are discharged before commencing work.
 - Anti-static precautions have been taken.

Removing components of the door assembly

1.



Insert one suitable metal pin (length: 10 mm / 0.4 in) per door hinge into the corresponding holes marked up in the image to lock the door hinge.

Ensure the pins remain in this position until the door is fitted to the oven again.

2.



Tilt the oven door to an angle of approx. 30° relative to the ground.

3.



Remove the door assembly from the oven performing a rotational movement of lifting the door up and pulling it away from the casing.

4.



Unfasten two M5.5 hex head flange bolts next to the door hinges to remove the cover panel from the door frame.

5.



Turn the door assembly around.
Slide the cover panel away from the door handle to remove it from the door frame.

6.



Remove the two thermal insulation pads located between the springs attached to the door hinges and the door handle.

7.



Unfasten two M8 hex cap screws on each side.
Detach the door handle.

8.



Remove all insulation pads/mats from the door.

9.

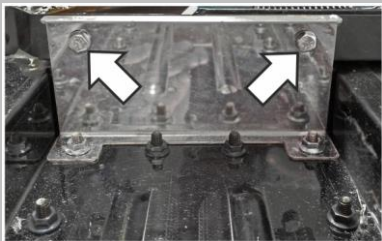

Unfasten two M8 hex cap screws.

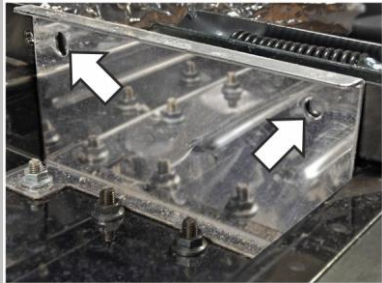

10.



Remove/replace the door hinge units if required.

Fitting the components of the door assembly

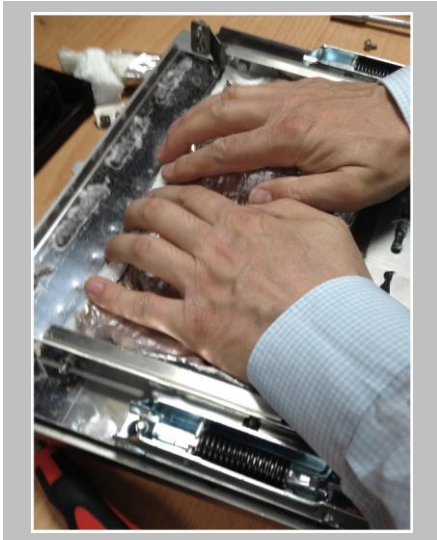

Follow the steps in the reverse order to reassemble the components of the oven door and to fit it to the oven.

NOTE:

Carefully refit the insulation pads/mats to their original positions.

12.5 Replacing a magnetron

Component



The magnetron(s) is/are located on top of the cavity and is/are fixed to the cooling duct and the cavity roof.

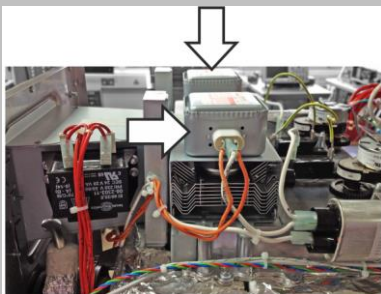

The 2000W e2s variant comprises two magnetrons located on the left and right hand sides of the cooling duct.



The cooling duct covers one side of the magnetron where the magnetron is attached to the cavity roof with two screws.

The image shows a single magnetron 1000W e2s variant.



The outlet of the cooling duct carries heat to the back of the oven and is covered by a grille.
The outlet comprises a sheet metal frame containing holes corresponding to the positions of Pozidriv screws securing the cooling duct to the magnetron.
Use these holes for guiding the Pozidriv screwdriver.

Tools required

Hammer or similar tool
PZ2 Pozidriv screwdriver
M8 hex socket wrench

Requirements

Check that the following requirements have been met:

- The appliance has been disconnected from the power supply and protective measures have been taken to ensure the power cannot be switched on again.
- The appliance is cool.
- The top, left and right panels of the casing of the appliance have been removed.
- The high voltage capacitors are discharged before commencing work.
- Anti-static precautions have been taken.

Preparing a spare magnetron

1.

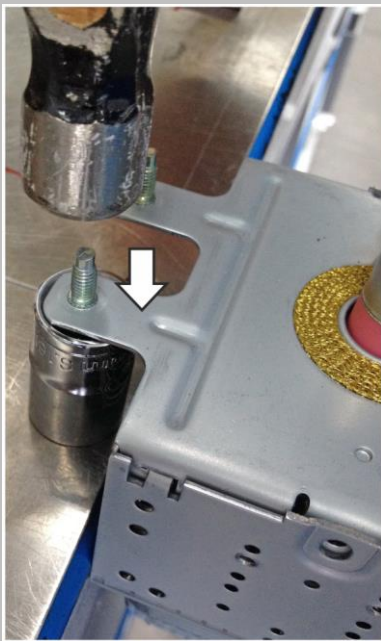

The spare magnetron comes with four pressed bolts. Remove the bolts before fitting the magnetron to the oven.

NOTE:

The bolts can be removed by knocking them out of the tabs with a hammer.

Ensure the tabs do not get bended. Secure them by laying them upon a piece of tube while pushing out the screws.

CAUTION:

Wear personal protective equipment to protect your fingers when using the hammer.

2.

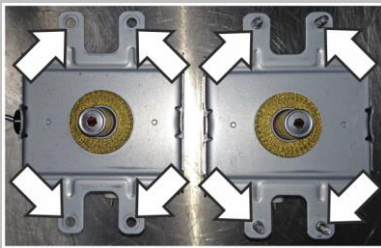

Comparison of spare magnetrons with (right) and without (left) pressed bolts.

Removing a magnetron

1.

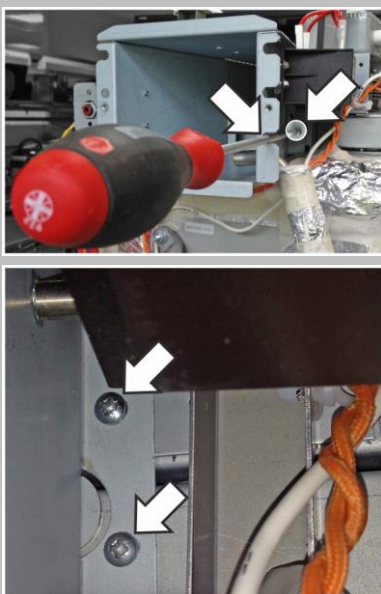

Unfasten two Pozidriv screws on the right side of the cooling duct with a long PZ2 Pozidriv screwdriver using the corresponding access holes at the cooling duct (when looking at the back side of the oven).

NOTE:

The picture shows the right side of the cooling duct seen from the outlet of the ducting.

2.

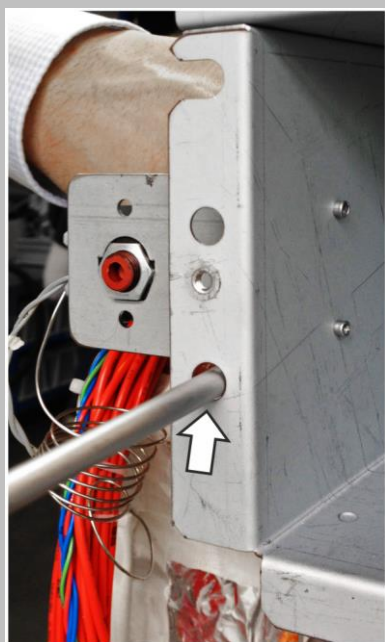

Unfasten one Pozidriv screw on the left side of the cooling duct with a long PZ2 Pozidriv screwdriver using the corresponding access hole at the cooling duct (when looking at the back side of the oven).

NOTE:

The number of screws on the left side of the cooling duct depends on the number of magnetrons fitted.

One magnetron (1000W e2s variant): one screw

Two magnetrons (2000W e2s variant): three screws

NOTICE:

When detaching the cooling duct be careful not to damage the exhaust pipe leading into the duct.

3.

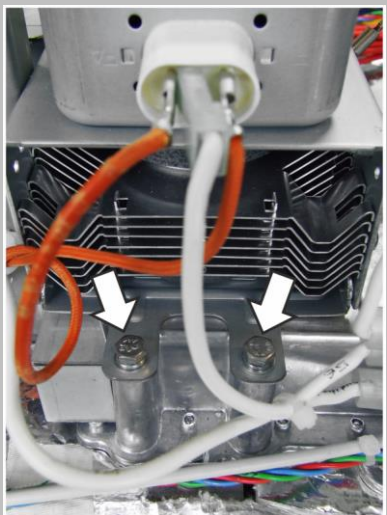
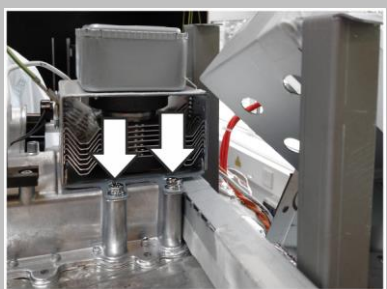

Unfasten four M8 hex cap screws to remove the magnetron. There is one pair of screws on each side of the magnetron. Disconnect any cables leading into the magnetron(s).

Fitting a magnetron

Follow the steps in the reverse order to fit a spare magnetron.

⚠ WARNING

Ensure nothing becomes trapped under the magnetron mounting points (e. g. insulation material) while fitting the magnetron. This can lead to microwave leakage.

NOTICE:

If the electric connections have not been restored properly this may lead to malfunction/damage of the oven.

12.6 Replacing the cooling fan

Component

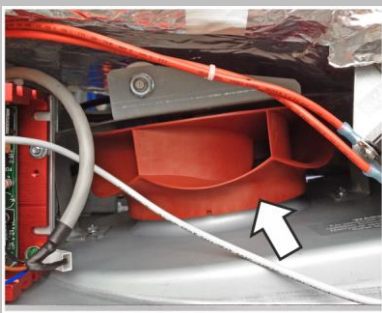

The cooling fan is located under the cavity and can be accessed by removing the convection fan motor speed controller.

Tools required

M7 hex socket wrench

Requirements

Check that the following requirements have been met:

- The appliance has been disconnected from the power supply and protective measures have been taken to ensure the power cannot be switched on again.
- The appliance is cool.
- The top and side panels of the casing of the appliance have been removed.
- The cooling fan speed controller is removed.
- The high voltage capacitors are discharged before commencing work.
- Anti-static precautions have been taken.

Removing the cooling fan

1.

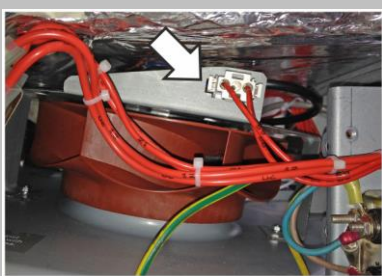

Unplug the electrical connection of the cooling fan on the right hand side of the appliance.

2.



Unfasten two M7 hex nuts each securing one arm of the sheet metal bracket which holds the cooling fan. Then turn the bracket clockwise.

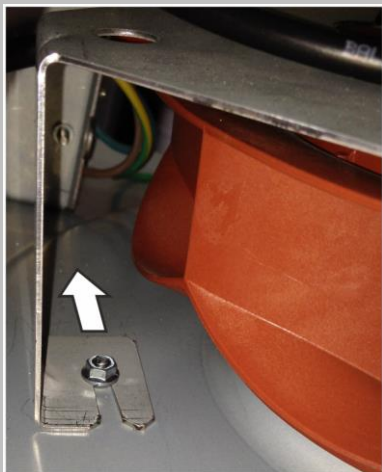

3.

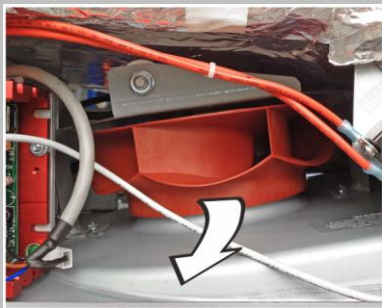

Twist and remove the cooling fan via the left hand side of the oven (when looking at the oven from the front).

Fitting the cooling fan

Follow the steps in the reverse order to fit the cooling fan.

NOTICE:

If the electric connections have not been restored properly this may lead to malfunction/damage of the oven.

12.7 Replacing the QTS (Quick Touch Screen) assembly

Component

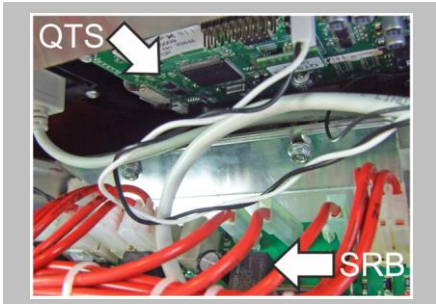

Top section (picture on the left):

The QTS (Quick Touch Screen) board lies behind the easyToUCH screen and is attached to the front panel of the oven.

Bottom section (picture on the left):

The much larger SRB (System Relay Board) extends over the whole width of the oven and rests in a tilted position close to the front panel of the oven. It is mounted to the frame of the casing.

Tools required

M5.5 hex socket wrench

Requirements

Check that the following requirements have been met:

- The appliance has been disconnected from the power supply and protective measures have been taken to ensure the power cannot be switched on again.
- The appliance is cool.
- The top and side panels of the casing of the appliance have been removed.
- The high voltage capacitors are discharged before commencing work.
- Anti-static precautions have been taken.

Removing the QTS assembly

1.



Disconnect all cables connecting the QTS assembly to the SRB.

2.



Remove the top front panel (including the touchscreen and QTS assembly) from the frame of the casing:
Unfasten two M5.5 hex head flange bolts fixing the front panel to the sheet metal frame.

3.

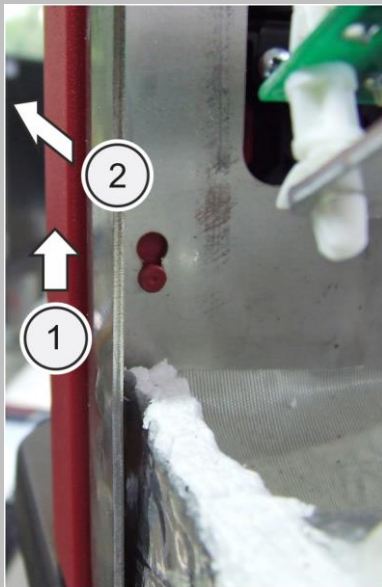

- 1) Slide the front panel upwards.
 - 2) Then carefully pull the front panel away from the sheet metal frame.
- Double check that all cables connecting the QTS assembly to the SRB have been removed.

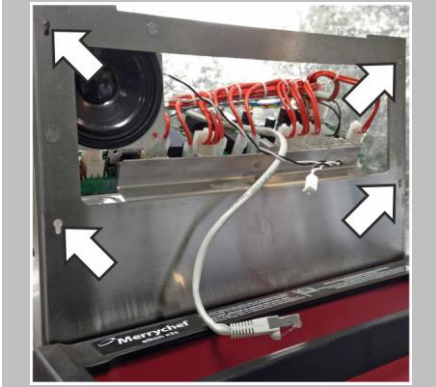

4.



Unfasten four M5.5 hex head flange bolts to remove the QTS assembly from the front panel.

5.

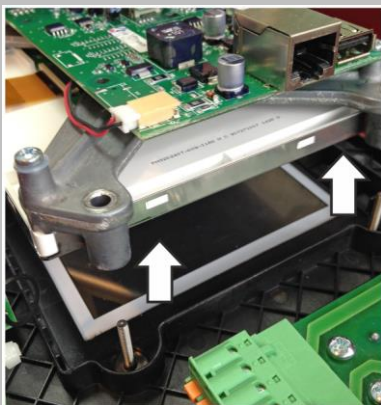

Lift out the QTS assembly.

6.

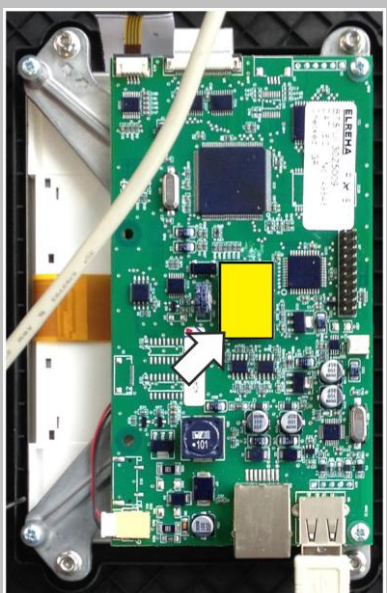

Remove the PM (Personality Module) from the QTS and place safely aside.

NOTICE:

Do not use tools to remove or refit the Personality Module.

Fitting the QTS assembly

Follow the steps in the reverse order to fit the QTS assembly.

Reconnect all electric connections to the QTS board.

Fit the PM removed from the old QTS to the new QTS.

Reason: Replacement QTS / SRB units come WITHOUT Personality Modules as they store individual settings saved by the user.

For details see “QTS Terminal Locations” (“Circuit diagrams” section).

NOTICE:

If the electric connections have not been restored properly this may lead to malfunction/damage of the oven.

12.8 Replacing the SRB (Smart Relay Board)

Component

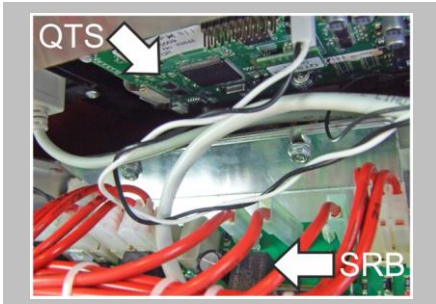

Bottom section (picture on the left):

The much larger SRB (System Relay Board) extends over the whole width of the oven and rests in a tilted position close to the front panel of the oven. It is mounted to the frame of the casing.

Top section (picture on the left):

The QTS (Quick Touch Screen) board lies behind the easyToUCH screen and is attached to the front panel of the oven.

Tools required

M7 hex socket wrench

Requirements

Check that the following requirements have been met:

- The appliance has been disconnected from the power supply and protective measures have been taken to ensure the power cannot be switched on again.
- The appliance is cool.
- The side and top panels of the casing of the appliance have been removed.
- The high voltage capacitors are discharged before commencing work.
- Anti-static precautions have been taken.

Removing the SRB

1.

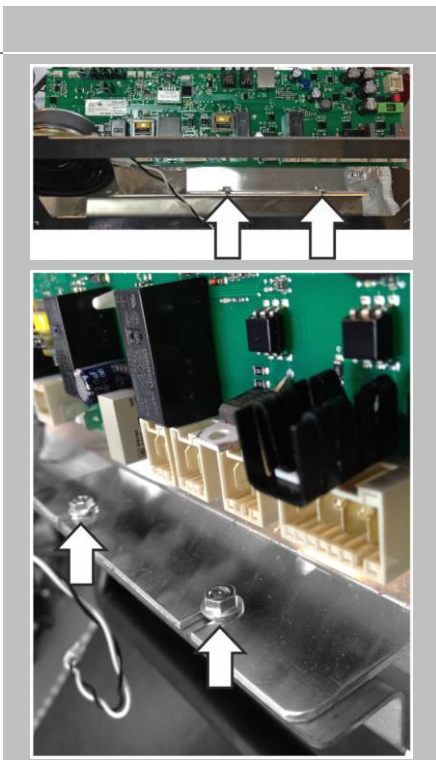

Disconnect all cables connecting the SRB to other components.

2.

Unfasten two M7 hex head flange bolts to remove the SRB from the frame of the casing.

3.



Remove the PM (Personality Module) from the SRB and place safely aside.

NOTICE:

Do not use tools to remove or refit the Personality Module.

Fitting the SRB

Follow the steps in the reverse order to fit the SRB.

Reconnect all electric connections to the SRB.

For details see "SRB Terminal Locations" ("Circuit diagrams" section).

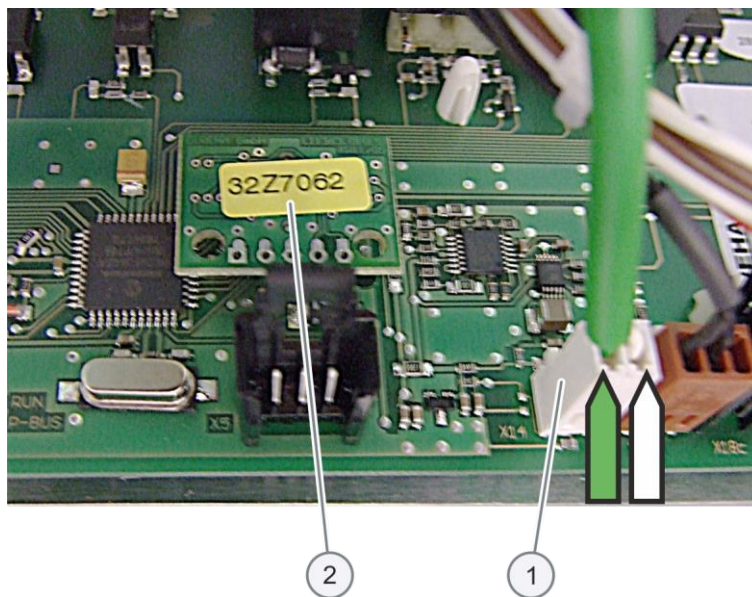

1. Ensure the thermocouple negative (-) connection (white) and positive (+) connection (green) are fitted the correct way round or the oven temperature readings will be wrong.
 2. Refit the Personality Module (PM) removed from the old SRB to the new SRB.
Reason: Replacement QTS / SRB units come WITHOUT Personality Modules as the PMs store individual settings saved by the user.
-

NOTICE:

If the electric connections have not been restored properly this may lead to malfunction/damage of the oven.

12.9 Replacing the touchscreen overlay

Component

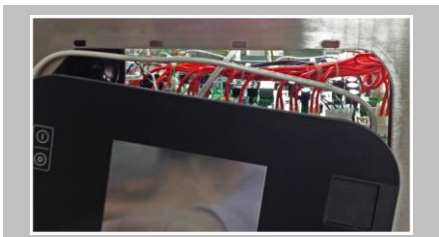

Tools required

M5.5 hex socket wrench

Requirements

Check that the following requirements have been met:

- The appliance has been disconnected from the power supply and protective measures have been taken to ensure the power cannot be switched on again.
- The appliance is cool.
- The high voltage capacitors are discharged before commencing work.
- Anti-static precautions have been taken.

Removing the touchscreen overlay

1.

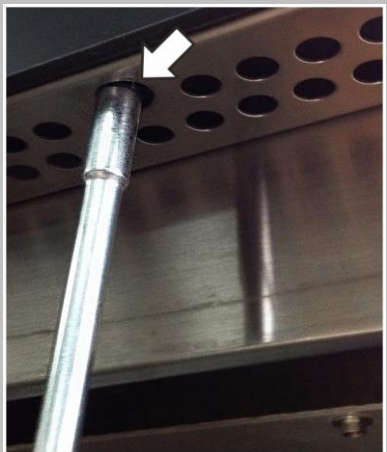

The touchscreen overlay can be removed without removing the side or back panels of the casing. There is an access hole for a locking screw underneath the front panel.

Release the screw using a M5.5 hex socket wrench.

2.

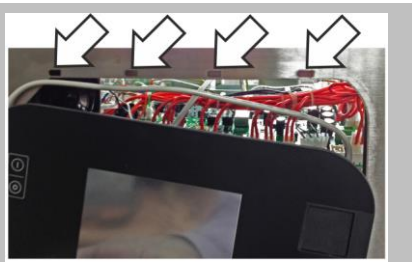

Slide the touchscreen element to the left and detach it from the frame of the casing.

NOTICE:

Mind the cables attached to the QTS assembly.

Fitting the touchscreen overlay

Follow the steps in the reverse order to fit the touchscreen overlay.

NOTICE:

If the electric connections have not been restored properly this may lead to malfunction/damage of the oven.

12.10 Adjusting the door microswitches / interlocks

Component



Adjust the microswitches after replacing old with new door hinges.
Micro-switch alignment is NOT required if just refitting the same door.

Tools required

M7 hex socket wrench

Requirements

Check that the following requirements have been met:

- The appliance has been disconnected from the power supply and protective measures have been taken to ensure the power cannot be switched on again.
- The appliance is cool.
- The top and side panels of the casing of the appliance have been removed.
- The high voltage capacitors are discharged before commencing work.
- Anti-static precautions have been taken.

Adjusting the door microswitches

1.

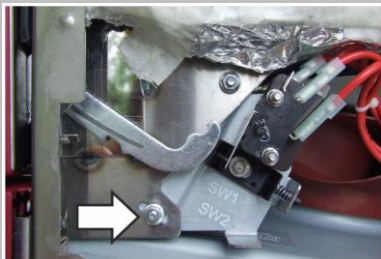

Located on the door hinges are 3 safety interlock microswitches, to prevent microwave emissions escaping when the oven door is opened:

The primary microswitch (SW3) breaks the electrical supply circuit to the transformers.

The secondary microswitch (SW2) breaks the microwave circuit if the primary fails.

The monitor switch (SW1) will short out the microwave circuit blowing the fuse if both primary and secondary interlocks fail.

IMPORTANT:

In the event that the monitor switch causes the microwave circuit fuse to blow, the secondary (SW2) and monitor (SW1) microswitches must be replaced due to exposure to high short-circuit currents.

The purpose of the following adjustment procedure is to set the interlock to switch off the microwave circuit when the door is opened more than 4 mm and for the microwave circuit to operate when the door is closed and the door seal expands.

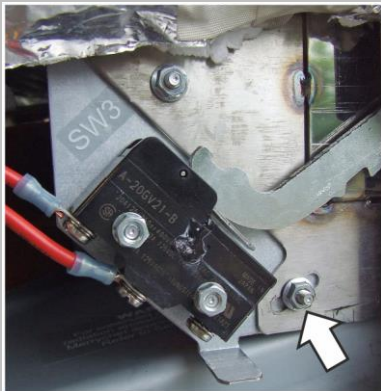

2.

Position green 2 mm spacers over the top corners of the door seal. Then carefully close the door ensuring the spacer is still in position.

3.		Slacken the pivot screw using a M7 hex socket wrench.
4.		Release the adjusting screws and move the backplate until microswitch SW3 just activates. Then secure all screws.
5.		Open the appliance door to replace the green 2 mm spacers with red 4 mm spacers and close the door.
6.		Slacken the pivot screw.
7.		Release the adjusting screws and move the backplate until microswitch SW2 just activates. Then secure all screws.
8.		Remove the spacers, then open and close the appliance door 5-10 times.

IMPORTANT:

Check if the switches operate in the following sequence as microswitch SW3 must switch the load current.

Closing the door:

- SW1 opens first
- SW2 closes second
- SW3 closes third

oven door open

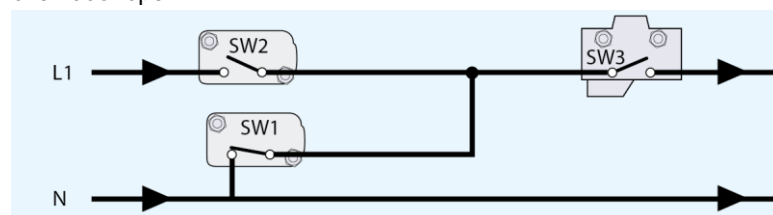

Opening the door:

- SW3 opens first
- SW2 opens second
- SW1 closes third

oven door closed

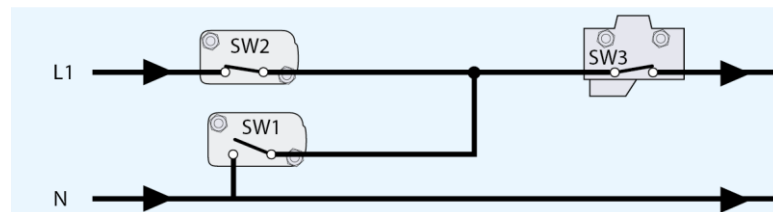

12.11 Replacing the stirrer motor

Component



Tools required

- M5.5 hex socket wrench
- M7 hex socket wrench
- Pozidriv PZ1 screwdriver

Requirements

Check that the following requirements have been met:

- The appliance has been disconnected from the power supply and protective measures have been taken to ensure the power cannot be switched on again.
- The appliance is cool.
- The casing of the appliance has been removed.
- The high voltage capacitors are discharged before commencing work.
- Anti-static precautions have been taken.

Removing the stirrer motor

1.



Unfasten two M5.5 hex head flange bolts to remove the jet/impinger plate from the roof of the cavity.

NOTE:

At the rear the jet/impinger plate rests in a bracket.

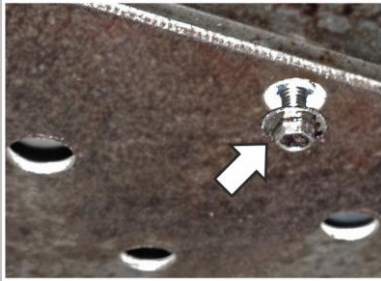

2.

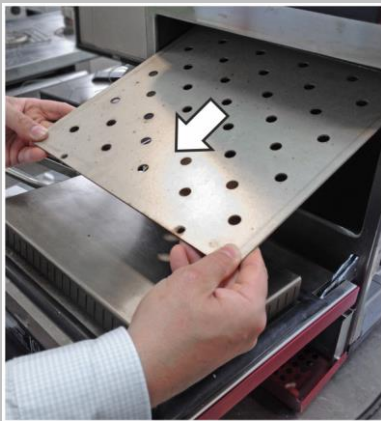

Remove the jet/impinger plate from the cavity.

3.

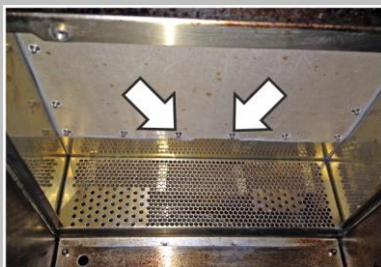

Unfasten sixteen (16) M7 hex nuts.
Be careful not to lose the washers.

4.

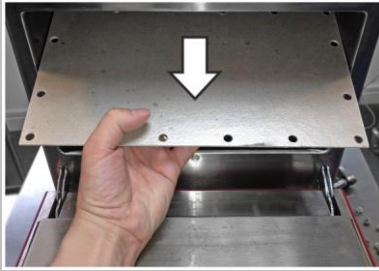

Remove the partition plate from the cavity.

NOTE:

The partition plate features a rubber gasket on the side pointing upwards (to the stirrer) when mounted.

The rubber gasket prevents grease laden air from soiling the stirrers and needs to be intact at any time.

5.

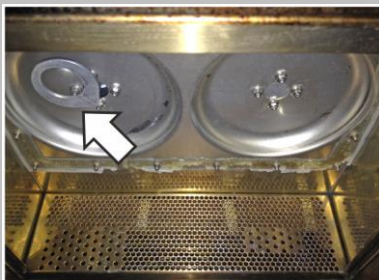

The image shows the 1000W e2s variant equipped with one stirrer/stirrer motor.

The 2000W e2s variant has a second stirrer/stirrer motor in the right niche.

6.

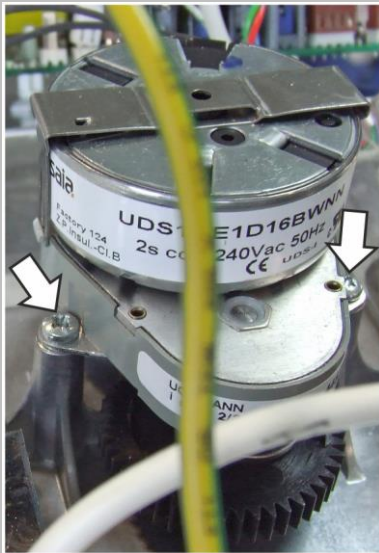

After removing the partition plate the stirrer motor on top of the cavity can be dismantled using a Pozidriv PZ1 screwdriver.

NOTE:

The threads at the stirrer motor are locked with Loctite.

Fitting the stirrer motor

Follow the steps in the reverse order to fit the stirrer motor.

IMPORTANT:

- When refitting the partition plate fasten the screws on opposite corners/sides in turns and do NOT proceed stringently clockwise or anti-clockwise.
- Tighten the partition plate screws to 2.1 Nm of torque.
- Tighten the jet/impinger plate screws to NO more than 1.8 Nm of torque.

12.12 Replacing the convection fan motor

Component

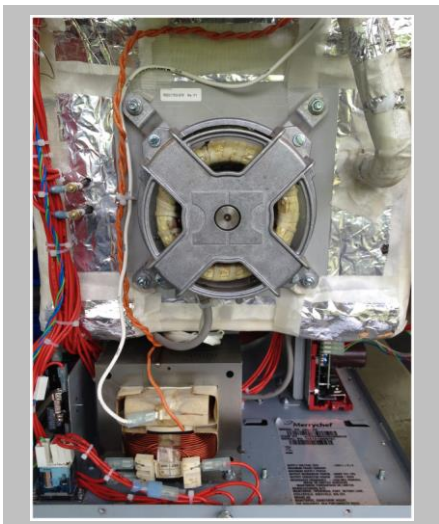

Tools required

M7 hex socket wrench

Requirements

Check that the following requirements have been met:

- The appliance has been disconnected from the power supply and protective measures have been taken to ensure the power cannot be switched on again.
- The appliance is cool.
- All panels of the casing of the appliance have been removed.
- The high voltage capacitors are discharged before commencing work.
- Anti-static precautions have been taken.

Removing/fitting the convection fan motor

1.

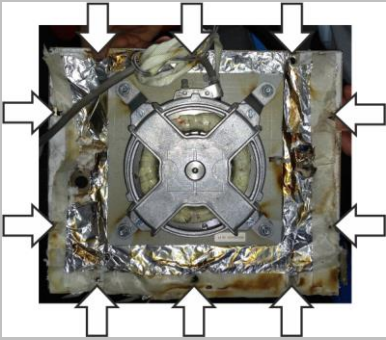
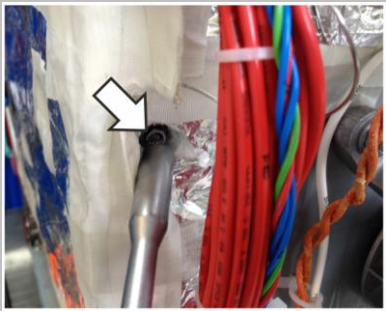

Identify ten screws fixing the plate carrying the convection fan motor to the rear of the cavity.

There are three screws close to the horizontal edges and two screws close to the vertical edges.

Carefully cut the tape covering the insulation mat with a knife to access the screws.

Unfasten ten M7 hex head flange bolts to remove the plate with the convection fan motor.

CAUTION:

Wear personal protective equipment to protect your fingers when using the knife.

NOTE:

The exhaust pipe is also connected to the rear plate. Be careful not to damage it when lifting out the plate.

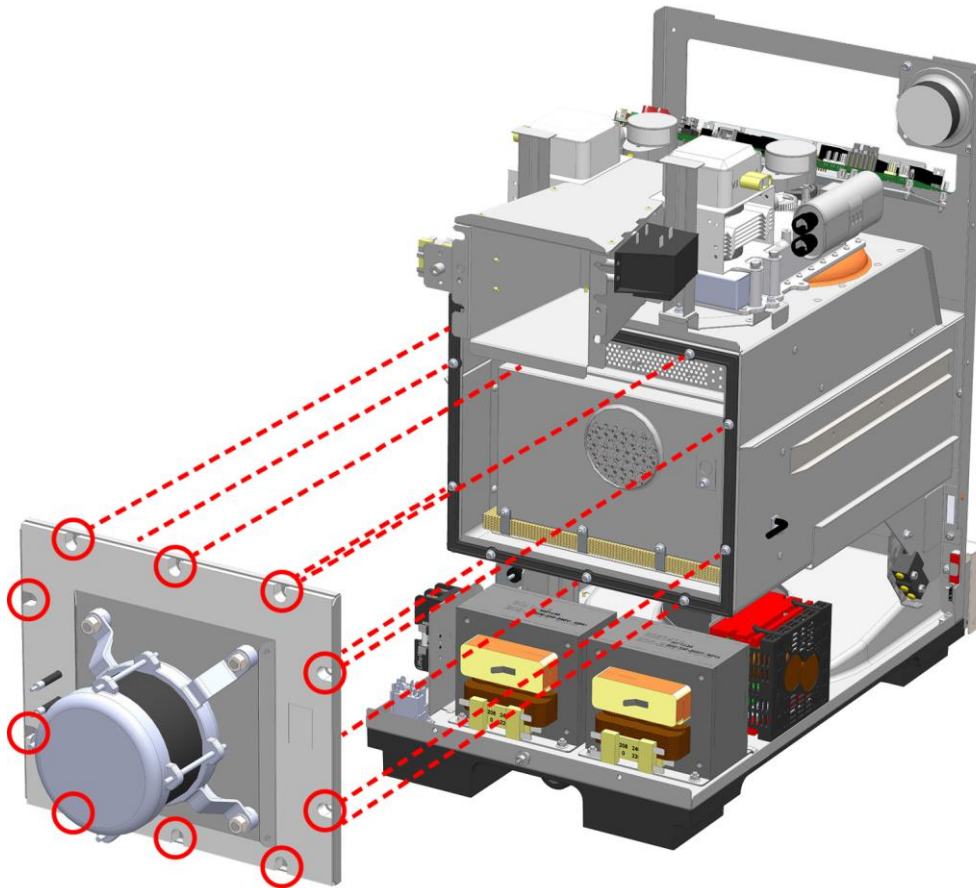

2.

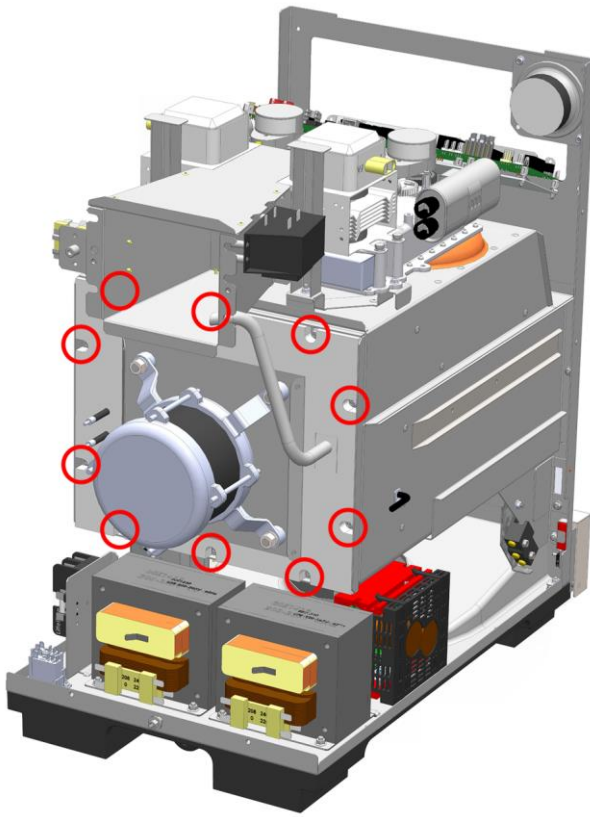

After replacement ensure the rear plate is fitted fully over the mounting points on the cavity before refitting and tightening the screws.

3.

Restore the tape sealing using heat-resistant tape recommended by the manufacturer.

12.13 Replacing a transformer (high voltage)

Component



1000W e2s variant: one high voltage transformer feeding the magnetron.



2000W e2s variant: two high voltage transformers side by side.

Tools required

M8 hex socket wrench

Requirements

Check that the following requirements have been met:

- The appliance has been disconnected from the power supply and protective measures have been taken to ensure the power cannot be switched on again.
- The appliance is cool.
- The casing of the appliance is removed.
- The high voltage capacitors are discharged before commencing work.
- Anti-static precautions have been taken.

Removing a transformer (high voltage)

1.

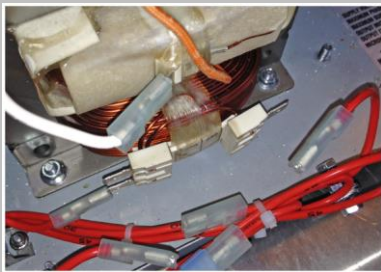

Unplug all electric connections of the transformer(s).

2.

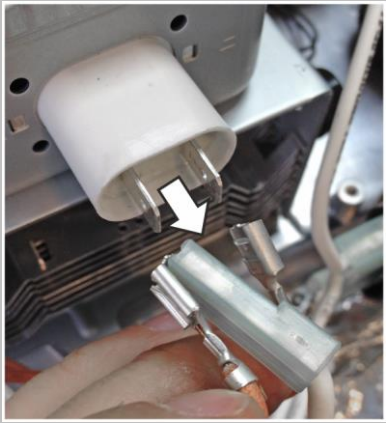

Disconnect the transformer(s) from the magnetron(s) by unplugging the orange cables at the magnetron(s).

3.

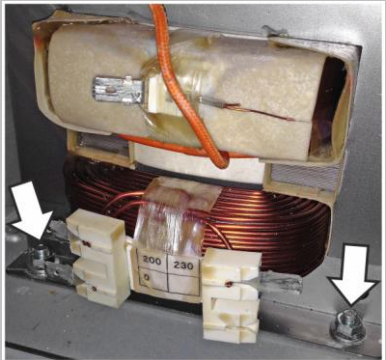

Unfasten two M8 nuts and washers to remove a transformer.

CAUTION:

The transformer is heavy.
Wear safety shoes to protect your feet from a transformer falling down.



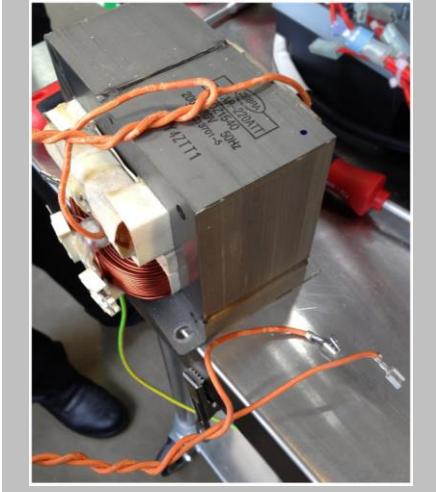

Fitting a transformer (high voltage)

Follow the steps in the reverse order to fit the high voltage transformer(s).

NOTICE:

If the electric connections have not been restored properly this may lead to malfunction/damage of the oven.

12.14 Removing the convection fan motor speed controller

Component



Remove the convection fan motor speed controller to access the cooling fan located behind it.

Tools required



M5.5 hex socket wrench

Requirements

Check that the following requirements have been met:

- The appliance has been disconnected from the power supply and protective measures have been taken to ensure the power cannot be switched on again.
- The appliance is cool.
- The casing of the appliance is removed.
- The high voltage capacitors are discharged before commencing work.
- Anti-static precautions have been taken.

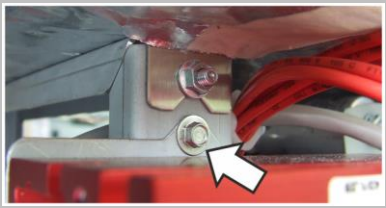
Removing/fitting the convection fan motor speed controller

1.  Unplug all electric cables connected to the convection fan motor speed controller.
2.  Unfasten one M5.5 hex head flange bolt to detach the convection fan motor speed controller.
3.  After replacement of the cooling fan reconnect the cables to the convection fan motor speed controller and refit the retaining screw.
Ensure the wiring of the speed controller is in accordance with the diagram below.

NOTE:
Incorrect wiring can lead to the convection fan motor running in reverse which will cause issues with cooking performance.

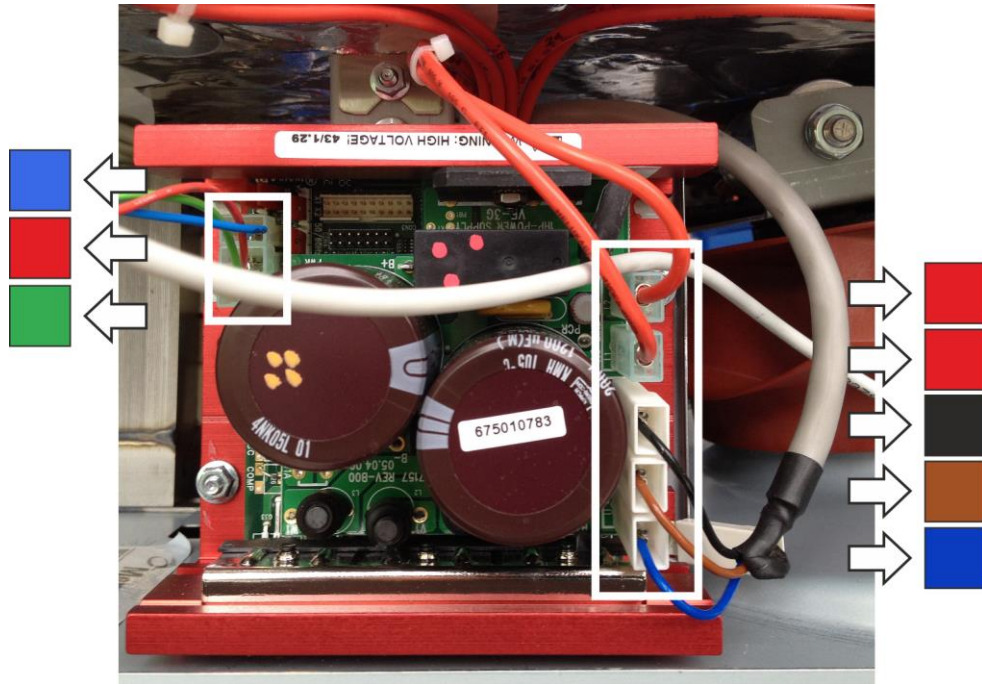

12.15 Overview - further components

Removable diffuser in the cavity (optional)

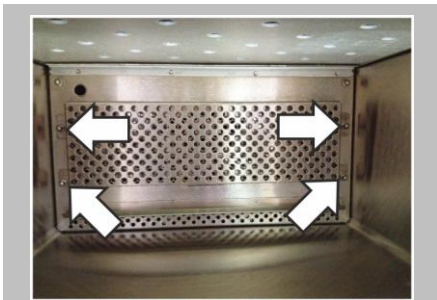

The rear air diffuser plate in the cavity is a customer option. It prevents large foodstuff from hitting the rear of the cavity.

Protective earth - connections to casing

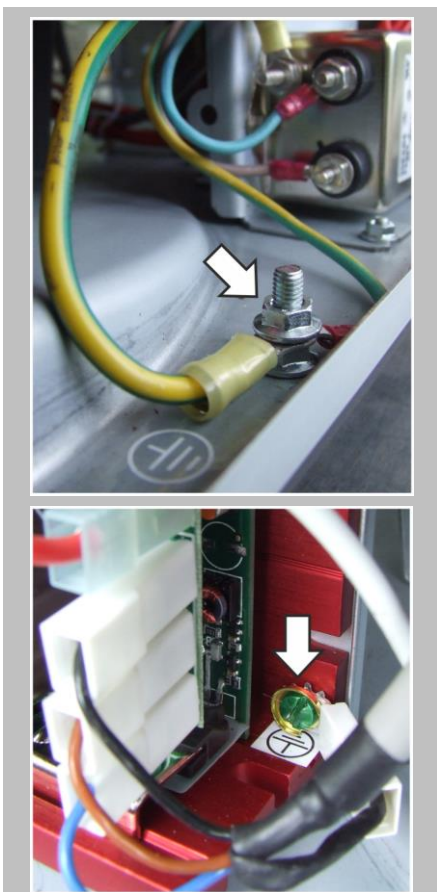

Equipotential bonding connection



Electromagnetic Compatibility (EMC) Filter(s)



*Top: one EMC filter unit (1000W e2s variant)
Bottom: two EMC filter units (2000W e2s variant)*

Diode(s) (high voltage)

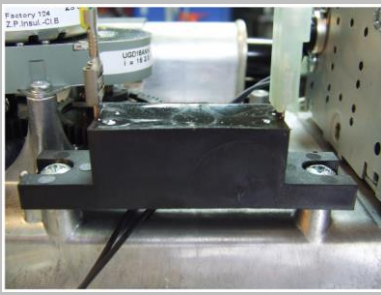

*Top: one high voltage diode (1000W e2s variant)
Bottom: two high voltage diodes (2000W e2s variant)*

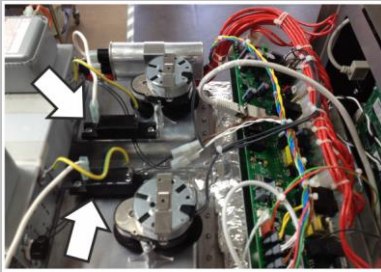

Exhaust pipe

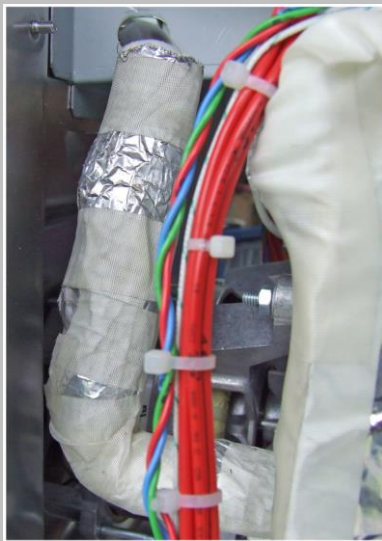

The exhaust pipe leads steam from the cavity to the cooling duct and the rear outlet of the oven.

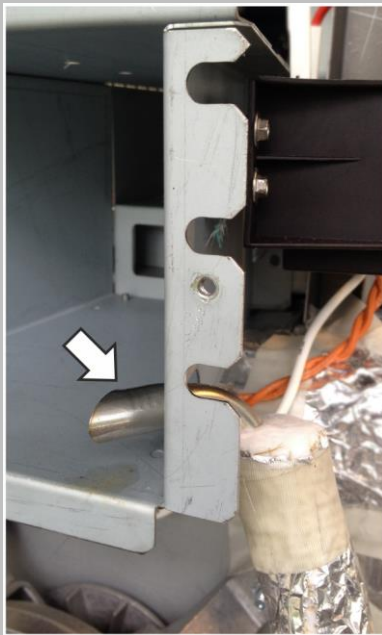

Cavity thermostat and cavity temperature sensor (thermocouple)

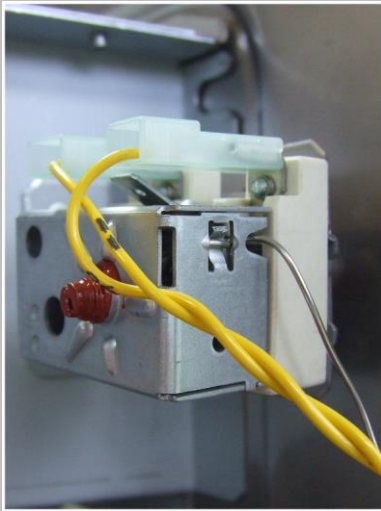

The cavity thermostat is located besides the cooling duct on the left hand side of the oven (when looking at the oven from the rear). It continuously measures the temperature in the cavity and prevents the cavity from overheating.

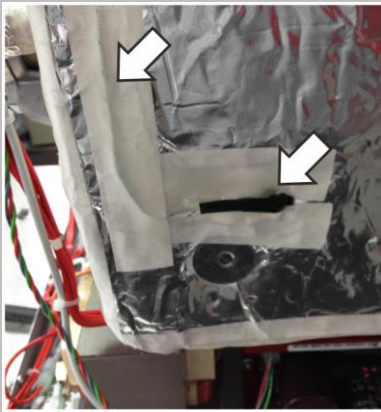

Measuring is done by a temperature sensor (thermocouple) which is essentially a wire extending between the cavity thermostat and the interior of the cavity. This temperature sensor wire runs along the left vertical edge of the cavity being attached to the cavity insulation with heat-resistant tape.

Cavity high limit

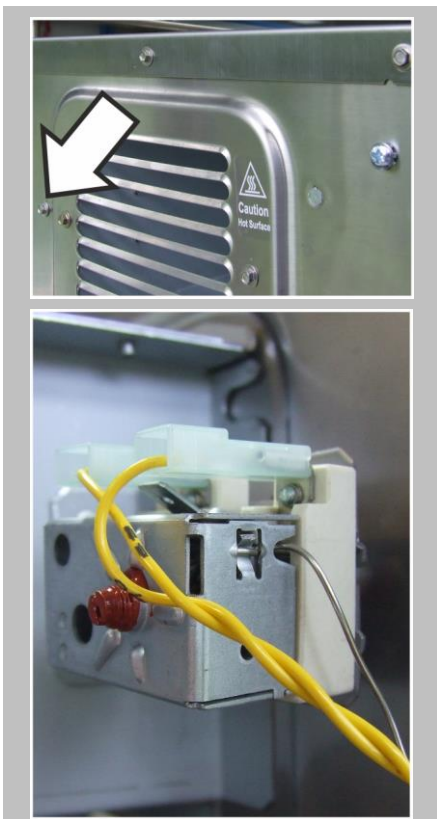

The cavity high limit (cavity temperature limiter) can be accessed via the rear panel on the left hand side of the grille.

Reset procedure:

- Remove the pictured M5.5 hex head flange bolt.
- Insert a terminal screwdriver (or similar) into the hole and push in the button to reset.
- After reset refit the M5.5 hex head flange bolt.

NOTE:

No live terminals are accessible through this port.
The panels of the casing do not need to be removed.

Transformer (low voltage)



The low voltage transformer is located besides the cooling duct on the left hand side of the appliance.

Capacitor(s) (high voltage)

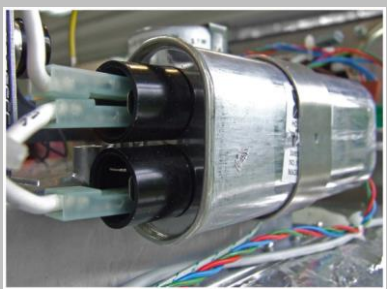

The high voltage capacitor is located on top of the cavity and is fixed by a sheet metal bracket.

The 2000W e2s variant comprises two high voltage capacitors each attributed to a magnetron.

Mains cable entering the interior

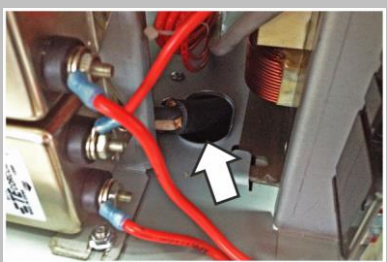

13 Circuit boards and diagrams

	Page
SRB / QTS circuit boards	184
Circuit diagrams	189

13.1 SRB / QTS circuit boards

SRB LEDs

- P-Bus – irregular flashing, indicating data communication with QTS.
- Run – Pulsing 1 second flash, indicating that the board has booted up.
- 12V and 5V – lit to show voltage outputs from inboard transformer.
- Relay and Triac – lit to show that a signal has been sent to energise that component.

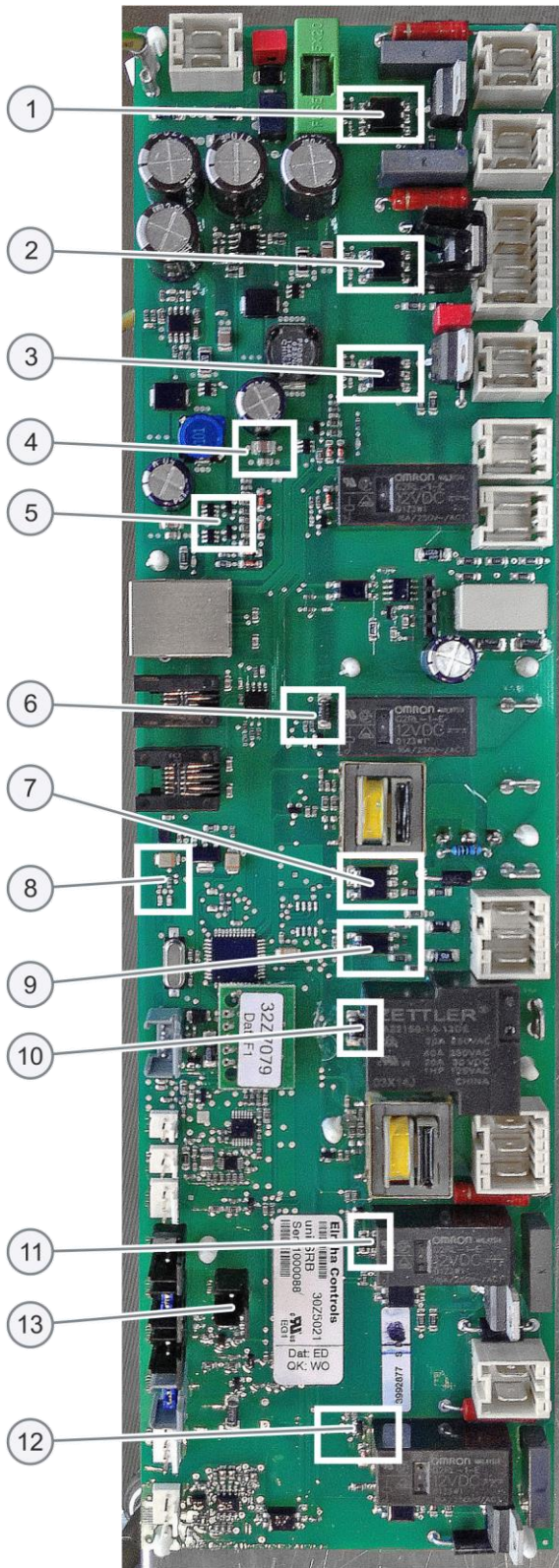

Item	Name
1	Cooling fan
2	Convection fan
3	Stirrer
4	5V supply
5	12V supply
6	Heater safety
7	Heater drive
8	P-Bus: flashes when data is being sent / received. RUN: 1 second flash.
9	Oven door
10	Microwave safety relay
11	Microwave 2 drive
12	Microwave 1 drive
13	LED (lit to show that a signal is received via overheat trips). If lit it is ok.

SRB Terminal Locations

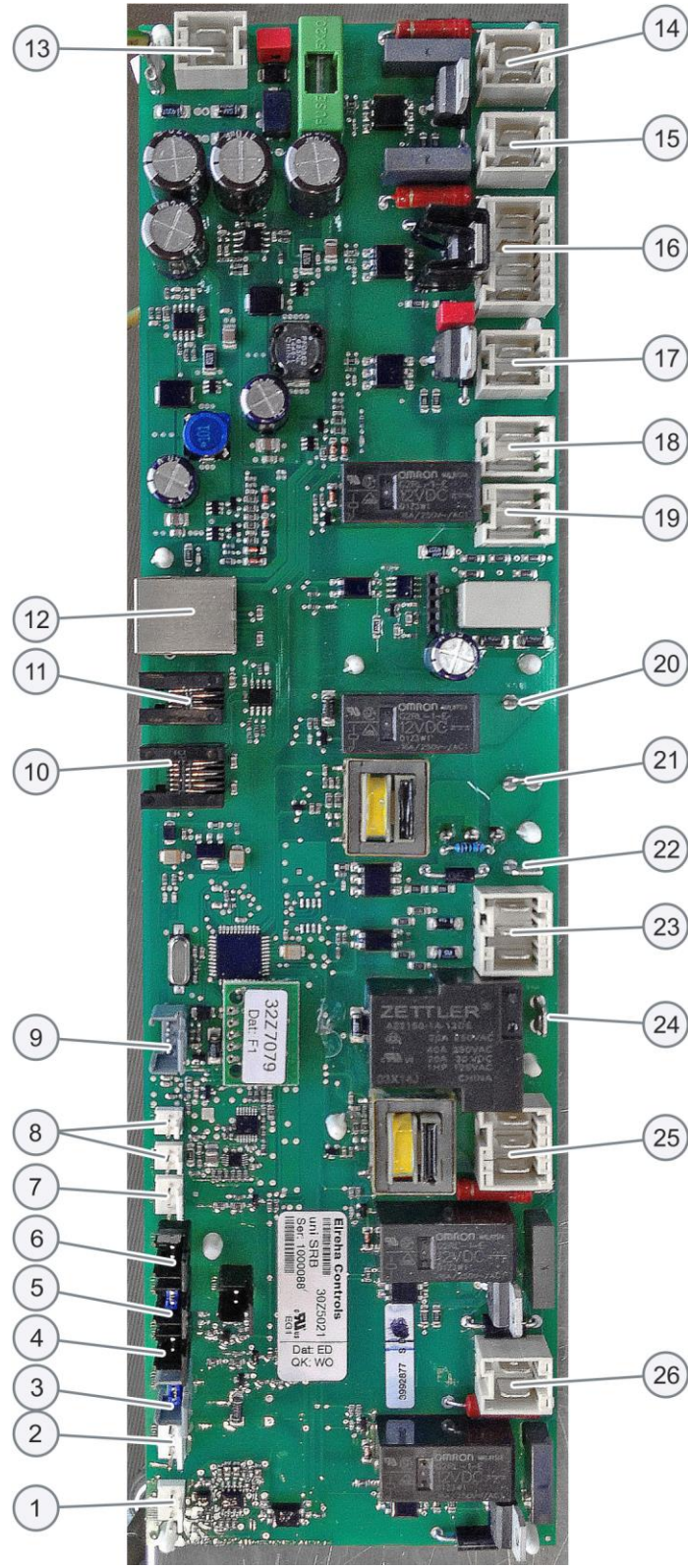

Item	Name
1	X3 – output for e2s convection fan motor speed controller.
2	X101 – voltage selection relay coil feeds. (US version only)
3	X18b – air filter reed switch.
4	X18e – right magnetron overheat thermostat.
5	X18d – left magnetron overheat thermostat.
6	X18c – cavity overheat thermostat.
7	X18a – On/Off switch.
8	X14 – cavity temperature temperature sensor (thermocouple).
9	X5 – fan RPM input.
10	X13 – P Bus, ethernet port.
11	X12 – C Bus, development PC port.
12	X11 – P/C Bus, BTS cable.
13	X1 – 24V supply from low voltage transformer.
14	X8 – cooling fan.
15	X17 – not used.
16	X20 – microwave stirrers.
17	X9 – mains output, convection fan controller.
18	X103.1 – mains output to low voltage transformer.
19	X103 – mains input, live and neutral.
20	X2.1 – mains input, live for heaters.
21	X2.2 – mains output, live to heaters.
22	X102a – mains input, neutral for magnetron transformers and monitor door switch.
23	X102b – mains output, neutral to magnetron transformers and monitor door switch.
24	X4a – door switch signal from secondary door switch (live for magnetron transformers).
25	X10 – connector block for door switches.
26	X4b – live for magnetron transformers

QTS LEDs

- Run – pulsing 1 second flash, indicating that the board has booted up.
- Power – lit to show that there is a power supply from the SRB.
- P-Bus – irregular flashing, indicating data communication with SRB.
- C-Bus – lit to show data being loaded from the Personality Module (PM) onto the QTS.
- LD5 – lit to show that a USB memory stick is fitted.

QTS Terminal Locations

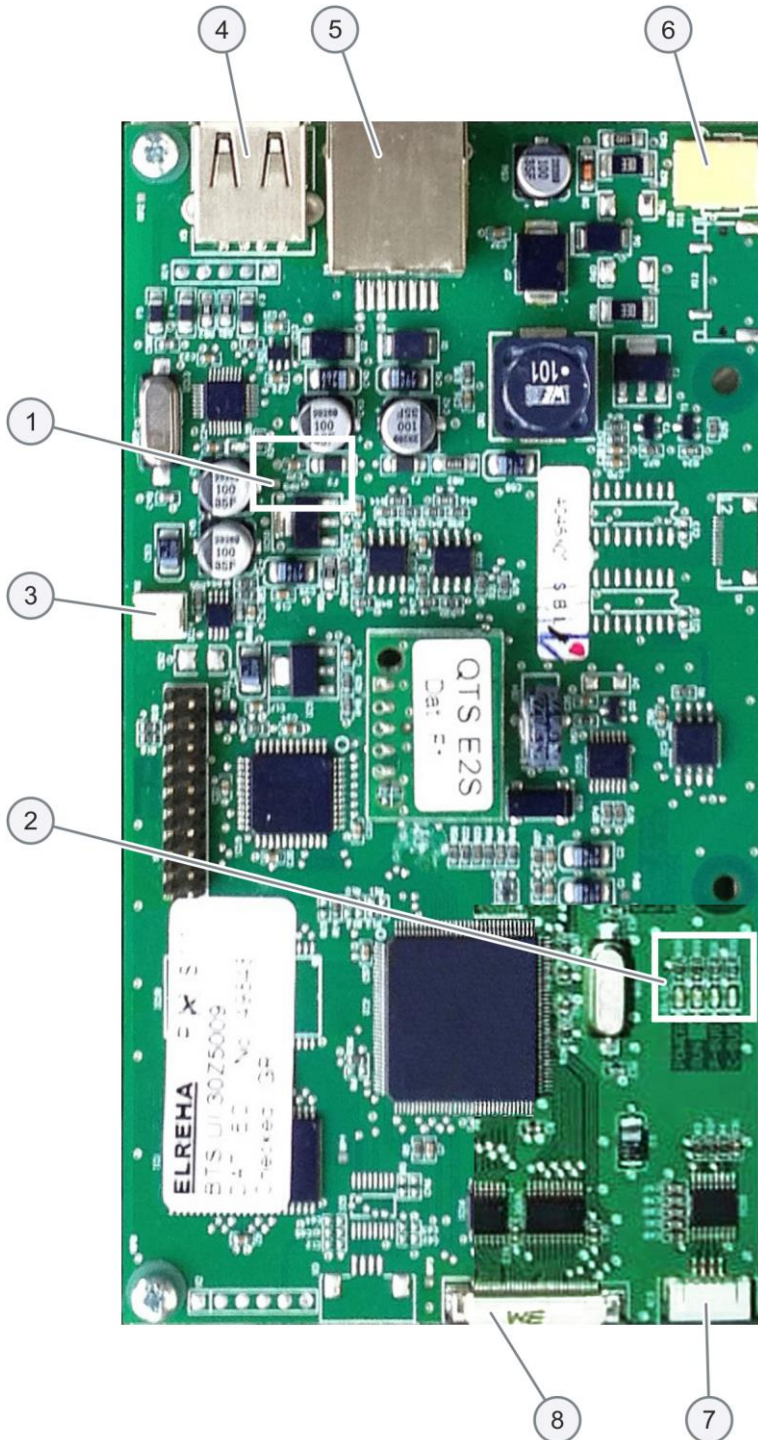

Item	Name
1	LD5
2	Power, Run, P-Bus, C-Bus
3	X6 – speaker
4	X5 – USB socket
5	X4 – communications to SRB
6	X11 – screen backlight
7	X13 – touch pad
8	X9 – display screen PCB

13.2 Circuit diagrams

e2s wiring diagram 50Hz 200/230V

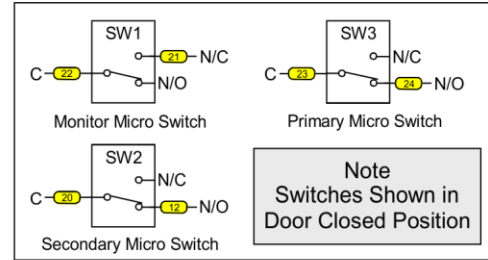
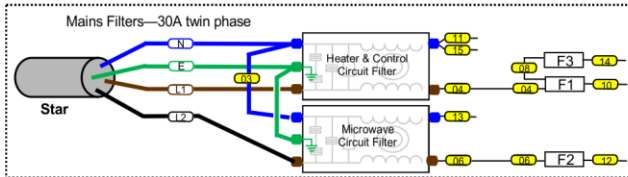
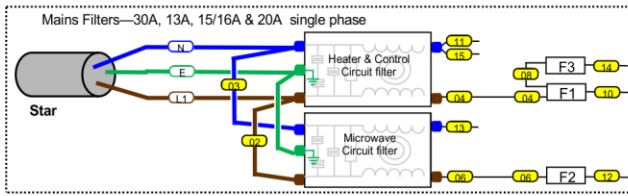

Fuse	Rating
F1	20 Amp
F2	20 Amp
F3	13 Amp

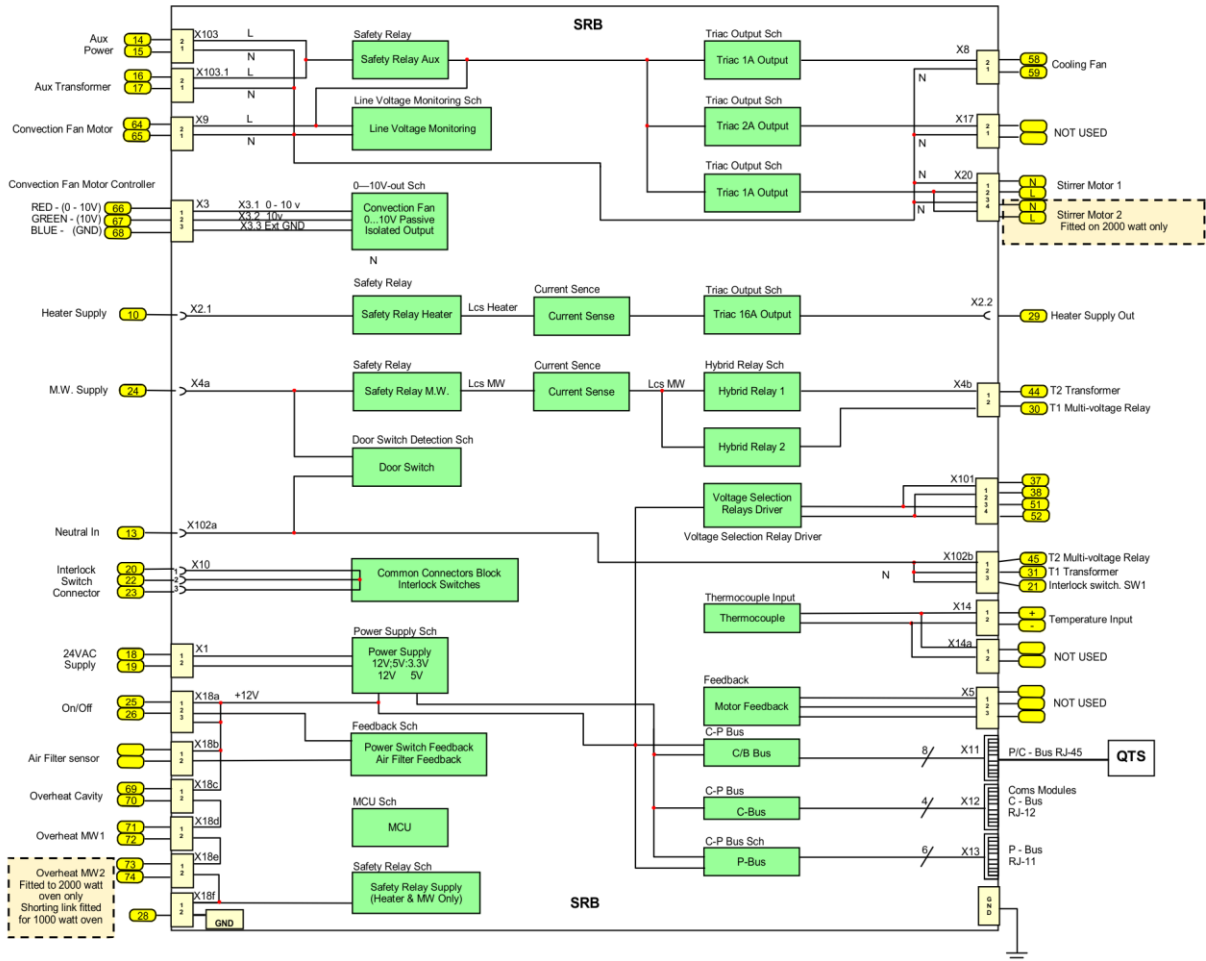
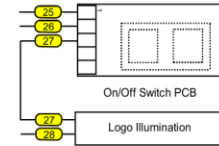

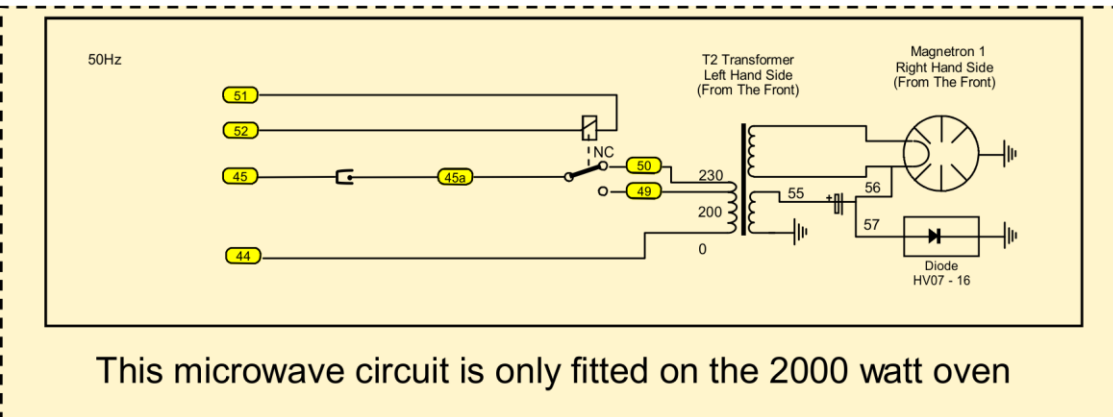
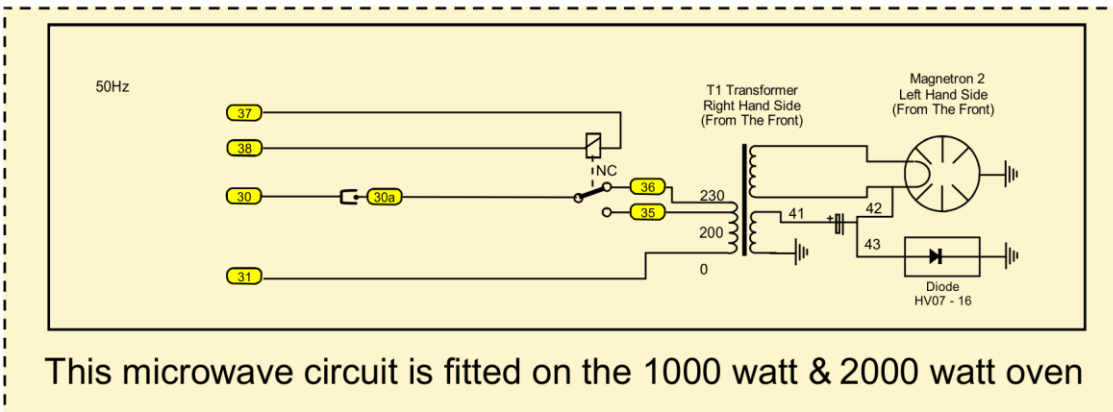
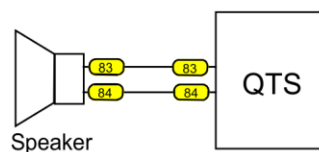
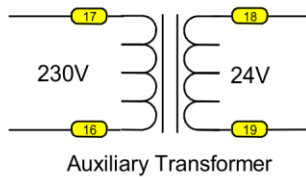
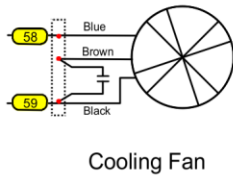
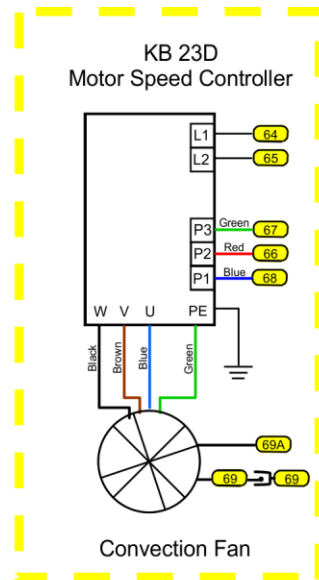
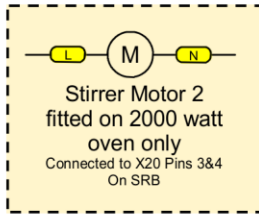
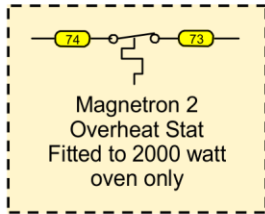
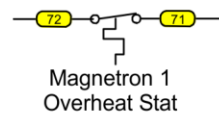
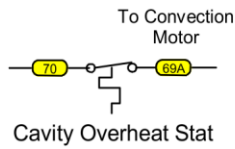

14 Commissioning the appliance

Recommission Test: Recommissioning the appliance after service/repair

The Recommission Tests are performed following the completion of a service or repair to ensure that the appliance is working correctly before handing back to the customer.

Some of the tests have a countdown timer where failing to carry out a test within the time limit will cause a test failure and the Recommission Test will have to be restarted.

1.

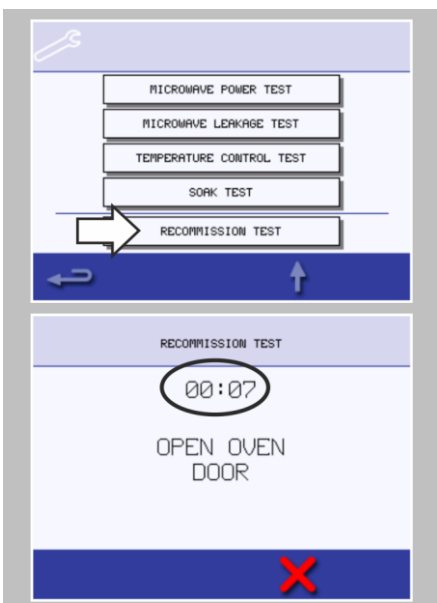

Select 'Recommission Test' from the Service Mode oven tests and follow the on screen instructions to perform the tests. Do not select the red 'X' unless you want to stop the test.

2.

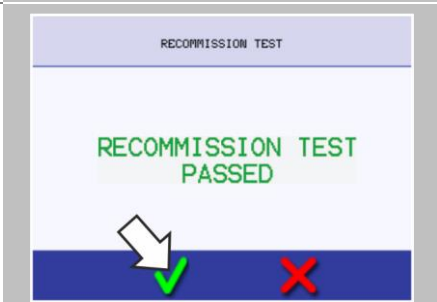

After a test has successfully passed, select the green check mark to continue.

3.



When all the tests have been successfully performed the display shows the Recommission Test has passed. Select the green check mark to confirm.

4.



In the event of a Recommission Test failure, the detail will be recorded in the Error Log. Rectify any error and repeat the Recommission Test.

Commissioning the oven after service/repair/testing

Complete the following checks after the oven has been serviced/repared/tested before connecting to the mains electricity power supply:

1. All internal electrical connections are correct (see "Electrical circuit diagrams").
2. All wiring insulation is correct and is not touching any sharp edges.
3. All grounding connections are electrically and mechanically secure.

14 Commissioning the appliance

4. All door safety interlocks are secure and mechanically sound.
5. The door activates all of the door interlock switches and in the correct order.
6. The door operation is smooth, and the arms run freely in the slots.
7. The temperature sensor (thermocouple) is correctly connected to the SRB.
8. The casing is securely refitted with no trapped wires.

Before finishing a service call, recheck the following points:

9. Run the recommission tests to ensure the oven is functioning correctly and the touch screen is working.
10. Microwave emissions are below the permissible limit of 5 mW/cm².
11. The power output of the oven is checked in accordance with the procedure.
12. The oven has a correct air gap of 50 mm / 2 inches above.
Air flow should not be restricted.
13. Complete the service report.

Microwave Combination Oven

Merrychef eikon e2s

Part Number 32Z3935

Issue 05 – 10/2019

Welbilt is one of the world's largest manufacturers and suppliers of professional gastronomic appliances.
We supply our customers with energy-saving, reliable and market-leading technologies from a single source.

If you want to find out more about Welbilt and its company brands,
please visit us at www.welbilt.com

